

Jergens®



KEYLOCKING THREADED INSERTS



MS/NAS Style

Industrial Style

Inch

Metric

Blind End Style

Floating Style

Cast-In Style

Kits

Keylocking Studs

Swage-Sert® (Thin Wall)

General Information



Acme Keylocking Threaded Inserts are used to quickly repair stripped, damaged or worn out threads with new stronger threads or for use in original equipment. Acme Inserts are easy to install and easy to remove. No special drills, taps or pre-winder tools are required. The Keys are driven down into the threads of the surrounding base material, locking the insert in place.



Acme can manufacture Keylocking Threaded Inserts to meet your special requirements. Some of our capabilities are listed below:

Materials (Inserts) -

303 Stainless
304 Stainless
316 Stainless
17-4 PH Stainless
A286 Stainless
Nitronic 60 Stainless
4140 Alloy
Inconel 718
Carbon Steel

Materials (Keys) -

302 Stainless
420 Stainless (Self-Broaching)

Finishes -

Zinc Phosphate
Passivate
Cadmium
Dry-Film Lube
Silver
Nickel

Features:

- Solid, one-piece insert construction provides a high degree of pull-out strength
- Keys supply a positive mechanical lock against rotation
- Easy installation and removal
- Installed with standard drills and taps
- No pre-winder tool required
- No tang to break-off
- May be used in many types of material
- MS/NAS Style inserts are produced to the following standards:

MS51830	NAS1395	NA0149
MS51831	NA0146	NA0150
MS51832	NA0147	NA0151
NAS1394	NA0148	

- Miniature, Lightweight, Heavy Duty, and Extra Heavy Duty types with Non-locking and Self-locking internal threads
- Full range of Inch and Metric sizes in coarse or fine pitch threads
- Inserts for specific uses are available in floating, blind end, solid, and cast-in configurations
- Industrial Style inserts can be purchased in bulk quantities or kits

Acme Industrial Company's manufacturing facility is certified to AS9100 and ISO 9001

NOTICE: Acme reserves the right to make changes without notice to our products and the information published about them. The material presented here is for guidance only. The user assumes full responsibility for determining the suitability of our products for a particular application. Requests for more information are welcome.

DISCLAIMER: SELLER MAKES NO OTHER WARRANTY WHATSOEVER, EXPRESSED OR IMPLIED AND ALL IMPLIED WARRANTIES OF MERCHANTABILITY AND FITNESS FOR A PARTICULAR PURPOSE ARE DISCLAIMED AND EXCLUDED FROM ALL TRANSACTIONS AND SHALL NOT APPLY TO THE GOODS SOLD.

REMEDY: Our obligation is limited to the repair or replacement of defective parts or, at our option, the refund of the purchase price. IN NO EVENT SHALL THE SELLER BE LIABLE FOR ANY INCIDENTAL, SPECIAL OR CONSEQUENTIAL DAMAGES, OR ANY DAMAGES IN THE NATURE OF PENALTIES.



Contents

Keylocking Threaded Inserts

Installation and Removal	2
MS/NAS Style Inserts	
Cross Reference	
Inch Sizes	
303 CRES.....	3
A286 CRES	4
4140 Alloy Steel.....	5
Metric Sizes	
A286 CRES	6
4140 Alloy Steel.....	6
Inch Sizes	
303 CRES	
Miniature & Lightweight	7
Heavy Duty	8
Extra Heavy Duty.....	9
A286 CRES	
Miniature & Lightweight	10
Heavy Duty	11
Extra Heavy Duty.....	12
4140 Alloy Steel	
Miniature & Lightweight	13
Heavy Duty	14
Extra Heavy Duty.....	15
Metric Sizes	
303 CRES	
Miniature & Lightweight	16
Heavy Duty	17
A286 CRES	
Miniature & Lightweight	18
Heavy Duty	19
4140 Alloy Steel	
Miniature & Lightweight	20
Heavy Duty	21
Integral Key Inserts	
303 CRES	22
A286 CRES	24
4140 Alloy Steel.....	23
Specific Use Inserts	
Blind End Inserts	24
Floating Inserts.....	26
Solid Inserts.....	27
Cast-In Inserts.....	28
Industrial Style Inserts	
Bulk Packed	
Inch Sizes	31
Metric Sizes	33
Metric Internal / Inch External Sizes	34
Single Size Kits	
Inch Sizes	32
Metric Sizes	33
Metric Internal / Inch External Sizes	33
Assortment Kits	34
Keylocking Studs	36
Swage-Sert® Thinwall Threaded Inserts	39

Installation & Removal Keylocking Threaded Inserts



Installation:

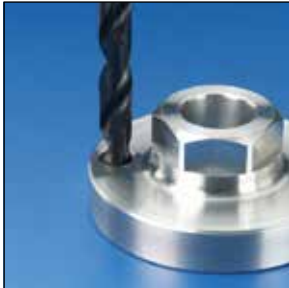

1) Drill with a standard tap drill and countersink with a standard 82° - 100° countersink (90° for Miniature Inserts). **Note:** Drill is oversize, see charts for proper dimensions.



2) Tap new threads with a standard tap. **Note:** See charts for proper size and depth.



3) Screw in the insert until it is .010-.030 (.005-.015 for Miniature Inserts) below the surface. Keys locate the proper depth.



4) Drive keys down with several hammer taps on the proper installation tool.



5) Properly installed insert.

Removal:

If necessary, Acme Keylocking Inserts can be removed without damage to the parent material:

- 1) Drill out material between keys and internal thread with a standard drill to specified depth (refer to charts for proper size and depth).
- 2) Bend the keys inward and break off.
- 3) Remove the old insert using a screw extractor or similar device.
- 4) Install a replacement insert into the original tapped hole and drive keys down.

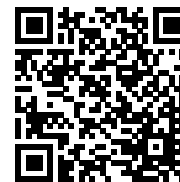

Watch the video

Scan this code to visit our website and watch the instructional video.



MS/NAS Style - 303 CRES Keylocking Threaded Inserts

Cross Reference - Inch

MINIATURE & LIGHTWEIGHT			HEAVY DUTY			EXTRA HEAVY DUTY		
MS51830	NAS1394	ACME P/N*	MS51831	NAS1395	ACME P/N*	MS51832	NAS	ACME P/N*
	C08	76288		C04	76290	-101		76333
	C08L	77288		C04L	77290	-101L		77333
-101		76283		C06	76291	-102		76334
-101L		77283		C06L	77291	-102L		77334
-102		76284		C08	76300	-103		76335
-102L		77284	-101	C08L	77300	-103L		77335
-103		76285	-101L		76301	-104		76336
-103L		77285	-102		77301	-104L		77336
-104		76286	-102L		76302	-105		76337
-104L		77286	-103		77302	-105L		77337
-105		76321	-103L		76303	-106		76338
-105L		77321	-104		77303	-106L		77338
-106		76322	-104L		76304	-107		76339
-106L		77322	-105		77304	-107L		77339
-107		76323	-105L		76305	-108		76340
-107L		77323	-106		77305	-108L		77340
-108		76324	-106L		76306	-109		76341
-108L		77324	-107		77306	-109L		77341
-109		76325	-107L		76307	-110		76342
-109L		77325	-108		77307	-110L		77342
-110		76326	-108L		76308	-111		76343
-110L		77326	-109		77308	-111L		77343
-201	C3	76521	-109L		76309	-201		76533
-201L	C3L	77521	-110		77309	-201L		77533
-202	C4	76522	-110L		76310	-202		76534
-202L	C4L	77522	-111		77310	-202L		77534
-203	C5	76523	-111L		76311	-203		76535
-203L	C5L	77523	-201	C3	77311	-203L		77535
-204	C6	76524	-201L	C3L	76501	-204		76536
-204L	C6L	77524	-202	C4	77501	-204L		77536
-205	C7	76525	-202L	C4L	76502	-205		76537
-205L	C7L	77525	-203	C5	77502	-205L		77537
-206	C8	76526	-203L	C5L	76503	-206		76538
-206L	C8L	77526	-204	C6	77503	-206L		77538
			-204L	C6L	76504	-207		76539
			-205	C7	77504	-207L		77539
			-205L	C7L	76505	-208		76540
			-206	C8	77505	-208L		77540
			-206L	C8L	76506	-209		76541
			-207	C9	77506	-209L		77541
			-207L	C9L	76507	-210		76542
			-208	C10	77507	-210L		77542
			-208L	C10L	76508	-211		76543
			-209		77508	-211L		77543
			-209L		76509			
			-210		77509			
			-210L		76510			
			-211		77510			
			-211L		76511			
					77511			

* To complete the abbreviated Acme part numbers in the table above use the prefix "217-0"

For inserts with the following options, add the letter code shown below to the end of the Acme part number:

S - Silver Plate per AMS 2410 **SN** - Silver Plate Only, No Dry Film Lube (Self-Locking Inserts Only)
K - Self Broaching Keys **DFL** - Dry Film Lube (Non-Locking Inserts Only)

See pages 7 - 9 for detailed specifications on Acme part numbers listed above.

MS/NAS Style - A286 CRES Keylocking Threaded Inserts



Cross Reference - Inch

MINIATURE & LIGHTWEIGHT			HEAVY DUTY			EXTRA HEAVY DUTY		
MS51830	NAS1394	ACME P/N*	MS51831	NAS1395	ACME P/N*	MS51832	NAS	ACME P/N*
	CA08	78288		CA04	78290	CA101		78333
	CA08L	79288		CA04L	79290	CA101L		79333
				CA06	78291	CA102		78334
CA101		78283		CA06L	79291	CA102L		79334
CA101L		79283		CA08	78300	CA103		78335
CA102		78284		CA08L	79300	CA103L		79335
CA102L		79284	CA101		78301	CA104		78336
CA103		78285	CA101L		79301	CA104L		79336
CA103L		79285	CA102		78302	CA105		78337
CA104		78286	CA102L		79302	CA105L		79337
CA104L		79286	CA103		78303	CA106		78338
CA105		78321	CA103L		79303	CA106L		79338
CA105L		79321	CA104		78304	CA107		78339
CA106		78322	CA104L		79304	CA107L		79339
CA106L		79322	CA105		78305	CA108		78340
CA107		78323	CA105L		79305	CA108L		79340
CA107L		79323	CA106		78306	CA109		78341
CA108		78324	CA106L		79306	CA109L		79341
CA108L		79324	CA107		78307	CA110		78342
CA109		78325	CA107L		79307	CA110L		79342
CA109L		79325	CA108		78308	CA111		78343
CA110		78326	CA108L		79308	CA111L		79343
CA110L		79326	CA109		78309	CA201		78533
CA201	CA3	78521	CA109L		79309	CA201L		79533
CA201L	CA3L	79521	CA110		78310	CA202		78534
CA202	CA4	78522	CA110L		79310	CA202L		79534
CA202L	CA4L	79522	CA111		78311	CA203		78535
CA203	CA5	78523	CA111L		79311	CA203L		79535
CA203L	CA5L	79523	CA201	CA3	78501	CA204		78536
CA204	CA6	78524	CA201L	CA3L	79501	CA204L		79536
CA204L	CA6L	79524	CA202	CA4	78502	CA205		78537
CA205	CA7	78525	CA202L	CA4L	79502	CA205L		79537
CA205L	CA7L	79525	CA203	CA5	78503	CA206		78538
CA206	CA8	78526	CA203L	CA5L	79503	CA206L		79538
CA206L	CA8L	79526	CA204	CA6	78504	CA207		78539
			CA204L	CA6L	79504	CA207L		79539
			CA205	CA7	78505	CA208		78540
			CA205L	CA7L	79505	CA208L		79540
			CA206	CA8	78506	CA209		78541
			CA206L	CA8L	79506	CA209L		79541
			CA207	CA9	78507	CA210		78542
			CA207L	CA9L	79507	CA210L		79542
			CA208	CA10	78508	CA211		78543
			CA208L	CA10L	79508	CA211L		79543
			CA209		78509			
			CA209L		79509			
			CA210		78510			
			CA210L		79510			
			CA211		78511			
			CA211L		79511			

* To complete the abbreviated Acme part numbers in the table above use the prefix "217-0"

For inserts with the following options, add the letter code shown below to the end of the Acme part number:

S - Silver Plate per AMS 2410 **SN** - Silver Plate Only, No Dry Film Lube (Self-Locking Inserts Only)
K - Self Broaching Keys **DFL** - Dry Film Lube (Non-Locking Inserts Only)

See pages 10 - 12 for detailed specifications on Acme part numbers listed above.



MS/NAS Style - 4140 Alloy Steel Keylocking Threaded Inserts

Cross Reference - Inch

MINIATURE & LIGHTWEIGHT			HEAVY DUTY			EXTRA HEAVY DUTY		
MS51830	NAS1394	ACME P/N*	MS51831	NAS1395	ACME P/N*	MS51832	NAS	ACME P/N*
	-08	80288		-04	80290	A101		80333
	-08L	81288		-04L	81290	A101L		81333
A101		80283		-06	80291	A102		80334
A101L		81283		-06L	81291	A102L		81334
A102		80284		-08	80300	A103		80335
A102L		81284	A101	-08L	81300	A103L		81335
A103		80285	A101L		80301	A104		80336
A103L		81285	A102		81301	A104L		81336
A104		80286	A102L		80302	A105		80337
A104L		81286	A103		81302	A105L		81337
A105		80321	A103L		80303	A106		80338
A105L		81321	A104		81303	A106L		81338
A106		80322	A104L		80304	A107		80339
A106L		81322	A105		81304	A107L		81339
A107		80323	A105L		80305	A108		80340
A107L		81323	A106		81305	A108L		81340
A108		80324	A106L		80306	A109		80341
A108L		81324	A107		81306	A109L		81341
A109		80325	A107L		80307	A110		80342
A109L		81325	A108		81307	A110L		81342
A110		80326	A108L		80308	A111		80343
A110L		81326	A109		81308	A111L		81343
A201	-3	80521	A109L		80309	A201		80533
A201L	-3L	81521	A110		81309	A201L		81533
A202	-4	80522	A110L		80310	A202		80534
A202L	-4L	81522	A111		81310	A202L		81534
A203	-5	80523	A111L		80311	A203		80535
A203L	-5L	81523	A201	-3	81311	A203L		81535
A204	-6	80524	A201L	-3L	80501	A204		80536
A204L	-6L	81524	A202	-4	81501	A204L		81536
A205	-7	80525	A202L	-4L	80502	A205		80537
A205L	-7L	81525	A203	-5	81502	A205L		81537
A206	-8	80526	A203L	-5L	80503	A206		80538
A206L	-8L	81526	A204	-6	81503	A206L		81538
			A204L	-6L	80504	A207		80539
			A205	-7	81504	A207L		81539
			A205L	-7L	80505	A208		80540
			A206	-8	81505	A208L		81540
			A206L	-8L	80506	A209		80541
			A207	-9	81506	A209L		81541
			A207L	-9L	80507	A210		80542
			A208	-10	81507	A210L		81542
			A208L	-10L	80508	A211		80543
			A209		81508	A211L		81543
			A209L		80509			
			A210		81509			
			A210L		80510			
			A211		81510			
			A211L		80511			
					81511			

* To complete the abbreviated Acme part numbers in the table above use the prefix "217-0"

Note: The Acme Part Numbers in the chart above are Cadmium Plated to QQ-P-416 Type II, Class 2.

This meets the requirements for both the MS and NAS specifications.

See pages 13 - 15 for detailed specifications on Acme part numbers listed above.

MS/NAS Style - Metric Keylocking Threaded Inserts



Cross Reference A286 CRES - Metric

MINIATURE			LIGHTWEIGHT			HEAVY DUTY		
Internal Thread	NA0147	ACME P/N*	Internal Thread	NA0149	ACME P/N*	Internal Thread	NA0151	ACME P/N*
MJ 2X0.4	-020	78382	MJ 5X0.8	-050	78351	MJ 4x0.7	-040	78363
MJ 2.5X0.45	-025	78383	MJ 6X1.0	-060	78352	MJ 5X0.8	-050	78364
MJ 3X0.5	-030	78384	MJ 8X1.0	-080	78553	MJ 6X1.0	-060	78365
MJ 4X0.7	-040	78386	MJ 10X1.25	-100	78555	MJ 8X1.0	-080	78566
MJ 3X0.5	E030	79384	MJ 12X1.25	-120	78556	MJ 10X1.25	-100	78567
MJ 4X0.7	E040	79386	MJ 5X0.8	E050	79351	MJ 12X1.25	-120	78569
			MJ 6X1.0	E060	79352	MJ 14X1.5	-140	78570
			MJ 8X1.0	E080	79553	MJ 16X1.5	-160	78571
			MJ 10X1.25	E100	79555	MJ 18X1.5	-180	78572
			MJ 12X1.25	E120	79556	MJ 20X1.5	-200	78573
						MJ 22X1.5	-220	78574
						MJ 24X2.0	-240	78575
						MJ 4X0.7	E040	79363
						MJ 5X0.8	E050	79364
						MJ 6X1.0	E060	79365
						MJ 8X1.0	E080	79566
						MJ 10X1.25	E100	79567
						MJ 12X1.25	E120	79569
						MJ 14X1.5	E140	79570
						MJ 16X1.5	E160	79571
						MJ 18X1.5	E180	79572
						MJ 20X1.5	E200	79573
						MJ 22X1.5	E220	79574
						MJ 24X2.0	E240	79575

* To complete the abbreviated Acme part numbers in the table above use the prefix "217-0"

See pages 18 & 19 for detailed specifications on Acme part numbers listed above.

Cross Reference 4140 Alloy Steel - Metric

MINIATURE			LIGHTWEIGHT			HEAVY DUTY		
Internal Thread	NA0146	ACME P/N*	Internal Thread	NA0148	ACME P/N*	Internal Thread	NA0150	ACME P/N*
MJ 2X0.4	-020	80382	MJ 5X0.8	-050	80351	MJ 4x0.7	-040	80363
MJ 2.5X0.45	-025	80383	MJ 6X1.0	-060	80352	MJ 5X0.8	-050	80364
MJ 3X0.5	-030	80384	MJ 8X1.0	-080	80553	MJ 6X1.0	-060	80365
MJ 4X0.7	-040	80386	MJ 10X1.25	-100	80555	MJ 8X1.0	-080	80566
MJ 3X0.5	E030	81384	MJ 12X1.25	-120	80556	MJ 10X1.25	-100	80567
MJ 4X0.7	E040	81386	MJ 5X0.8	E050	81351	MJ 12X1.25	-120	80569
			MJ 6X1.0	E060	81352	MJ 14X1.5	-140	80570
			MJ 8X1.0	E080	81553	MJ 16X1.5	-160	80571
			MJ 10X1.25	E100	81555	MJ 18X1.5	-180	80572
			MJ 12X1.25	E120	81556	MJ 20X1.5	-200	80573
						MJ 22X1.5	-220	80574
						MJ 24X2.0	-240	80575
						MJ 4X0.7	E040	81363
						MJ 5X0.8	E050	81364
						MJ 6X1.0	E060	81365
						MJ 8X1.0	E080	81566
						MJ 10X1.25	E100	81567
						MJ 12X1.25	E120	81569
						MJ 14X1.5	E140	81570
						MJ 16X1.5	E160	81571
						MJ 18X1.5	E180	81572
						MJ 20X1.5	E200	81573
						MJ 22X1.5	E220	81574
						MJ 24X2.0	E240	81575

* To complete the abbreviated Acme part numbers in the table above use the prefix "217-0"

See pages 20 - 21 for detailed specifications on Acme part numbers listed above.



MS/NAS Style - 303 CRES Keylocking Threaded Inserts

Material: Inserts - 303 CRES
Keys - 302 CRES

Finish: Passivated

Tolerances: ± 0.010 inch unless specified otherwise

Internal Threads: Per SAE AS8879

Dimensions: All dimensions below are in inches

Keys: Miniature Inserts are furnished with 2 locking keys

Material Identification Mark: None

Lubrication: Dry Film Lube on Self-Locking Inserts only

Performance: MIL-I-45914A (MS51830)

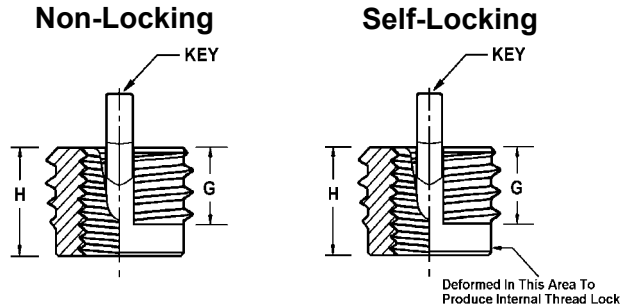

Miniature - Inch (See Page 3 for MS Part Number Cross Reference)

PART NUMBER ¹		INSERT				INSTALLATION					REMOVAL	
Non-Locking	Self-Locking	Internal Thread Class 3B	External Thread Class	G Thread Length	H Length	Install Tool Part No. ¹	Tap Drill Size $+0.003$ -0.001	C'Sink Dia. $+0.010$ -0.000	Thread Tap		Drill	
									Size Class 2B	Min. Depth	Size	Depth
76281	—	0 - 80	6 - 40 ²	.085	.100	72550	.118	.140	6 - 40	.240	#38	1/16
76282	77282	2 - 56	6 - 40 ²	.085	.100	72551	.118	.140	6 - 40	.240	#38	1/16
76283	77283	2 - 56	8 - 32 ³	.090	.120	72552	.134	.166	8 - 32	.140	#33	1/16
76284	77284	4 - 40	10 - 32 ³	.125	.170	72554	.161	.194	10 - 32	.160	#29	3/32
76285	77285	6 - 32	12 - 28 ³	.125	.170	72556	.187	.220	12 - 28	.160	#21	3/32
76286	77286	8 - 32	1/4 - 28 ⁴	.175	.220	72558	.228	.255	1/4 - 28	.210	#8	1/8

¹ To complete the abbreviated part number in the table above use the prefix "217-0"

² Class 3A ³ Class 2A ⁴ Class 2A and Modified Minor Diameter

Material: Inserts - 303 CRES
Keys - 302 CRES

Finish: Passivated

Tolerances: ± 0.010 inch unless specified otherwise.

Internal Threads: Per SAE AS8879

Dimensions: All dimensions below are in inches

Keys: Inserts with an internal thread size of 5/16 and larger are furnished with 4 locking keys. Smaller sizes have 2 locking keys.

Material Identification Mark: None

Lubrication: Dry Film Lube on Self-Locking Inserts only

Performance: MIL-I-45914A (MS51830 & NAS1394)

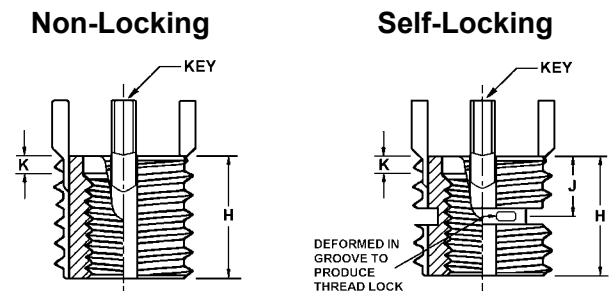

Lightweight - Inch (See Page 3 for MS/NAS Part Number Cross Reference)

PART NUMBER*		INSERT					INSTALLATION					REMOVAL	
Non-Locking	Self-Locking	Internal Thread Class 3B	External Thread (Mod.) Class 2A	H Length	J $\pm .030$	K C'Bore Depth	Install Tool Part No.*	Tap Drill Size ¹	C'Sink Dia. $+0.010$ -0.000	Thread Tap		Drill	
										Size Class 2B	Min. Depth	Size	Depth
76321	77321	10 - 24	5/16 - 18	.312	.22	.07	72568	.272	.323	5/16 - 18	.37	7/32	5/32
76521	77521	10 - 32					72569						
76322	77322	1/4 - 20	3/8 - 16	.375	.22	.07	72570	.332	.385	3/8 - 16	.43	9/32	3/16
76522	77522	1/4 - 28					72571						
76323	77323	5/16 - 18	7/16 - 14	.437	.22	.07	72572	.397	.447	7/16 - 14	.50	11/32	3/16
76523	77523	5/16 - 24					72573						
76324	77324	3/8 - 16	1/2 - 13	.500	.24	.07	72574	.453	.510	1/2 - 13	.56	13/32	3/16
76524	77524	3/8 - 24					72575						
76325	77325	7/16 - 14	9/16 - 12	.562	.27	.07	72576	.516	.572	9/16 - 12	.62	15/32	3/16
76525	77525	7/16 - 20					72577						
76326	77326	1/2 - 13	5/8 - 11	.625	.28	.07	72578	.578	.635	5/8 - 11	.68	17/32	3/16
76526	77526	1/2 - 20					72579						

* To complete the abbreviated part number in the table above use the prefix "217-0"

¹ Tap Drill Hole Tolerance: .234 to .500 = $+0.004/-0.001$
Over .500 = $+0.005/-0.001$

MS/NAS Style - 303 CRES Keylocking Threaded Inserts



Material: Inserts - 303 CRES
Keys - 302 CRES

Finish: Passivated

Tolerances: ±.010 inch unless specified otherwise.

Internal Threads: Per SAE AS8879

Dimensions: All dimensions below are in inches

Keys: Inserts with an internal thread size of 5/16 and larger are furnished with 4 locking keys. Smaller sizes have 2 locking keys.

Material Identification Mark: None

Lubrication: Dry Film Lube on Self-Locking Inserts only

Performance: MIL-I-45914A (MS51831 & NAS1395)

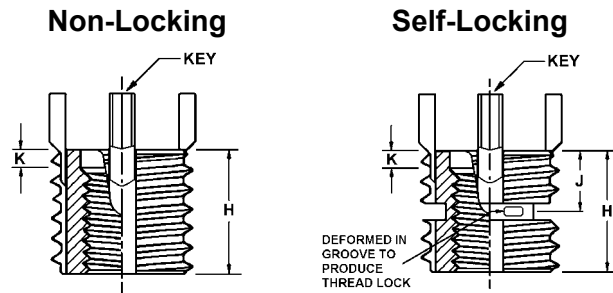

Heavy Duty - Inch (See Page 3 for MS/NAS Part Number Cross Reference)

PART NUMBER*		INSERT					INSTALLATION					REMOVAL	
Non-Locking	Self-Locking	Internal Thread Class 3B	External Thread (Mod.) Class 2A	H Length	J ±.030	K C'Bore Depth	Install Tool Part No.*	Tap Drill Size ¹	C'Sink Dia. +.010 -0.000	Thread Tap		Drill	
										Size Class 2B	Min. Depth	Size	Depth
76300	77300	8 - 32	5/16 - 18	.312	.22	.04	72590	.272	.323	5/16 - 18	.37	7/32	1/8
76301	77301	10 - 24	3/8 - 16	.312	.22	.07	72591	.332	.385	3/8 - 16	.37	9/32	1/8
76501	77501	10 - 32					72592						
76302	77302	1/4 - 20	7/16 - 14	.375	.22	.07	72593	.397	.447	7/16 - 14	.43	11/32	3/16
76502	77502	1/4 - 28					72594						
76303	77303	5/16 - 18	1/2 - 13	.437	.22	.07	72595	.453	.510	1/2 - 13	.50	13/32	3/16
76503	77503	5/16 - 24					72596						
76304	77304	3/8 - 16	9/16 - 12	.500	.25	.07	72597	.516	.572	9/16 - 12	.56	15/32	3/16
76504	77504	3/8 - 24					72598						
76305	77305	7/16 - 14	5/8 - 11	.625	.28	.10	72599	.578	.635	5/8 - 11	.68	17/32	3/16
76505	77505	7/16 - 20					72600						
76306	77306	1/2 - 13	11/16-11 NS	.688	.28	.10	72601	.641	.700	11/16-11 NS	.75	19/32	3/16
76506	77506	1/2 - 20					72602						
76307	77307	9/16 - 12	13/16 - 16	.812	.32	.10	72603	.766	.822	13/16-16	.94	23/32	3/16
76507	77507	9/16 - 18					72604						
76308	77308	5/8 - 11	7/8 - 14	.875	.33	.10	72605	.828	.885	7/8 - 14	1.00	25/32	3/16
76508	77508	5/8 - 18					72606						
76309	-	3/4 - 10	1-1/8 - 12	1.125	-	.10	72607	1.062	1.145	1-1/8 - 12	1.31	31/32	5/16
76509	-	3/4 - 16		1.250	.49		72608				1.44		
-	77309	3/4 - 10					72607						
-	77509	3/4 - 16					72608						
76310	-	7/8 - 9	1-1/4 - 12	1.250	-	.10	72609	1.187	1.270	1-1/4 - 12	1.44	1-3/32	5/16
76510	-	7/8 - 14		1.375	.49		72610				1.56		
-	77310	7/8 - 9					72609						
-	77510	7/8 - 14					72610						
76311	-	1" - 8	1-3/8 - 12	1.375	-	.10	72611	1.312	1.395	1-3/8 - 12	1.56	1-7/32	5/16
76511	-	1" - 12		1.500	.55		72612				1.68		
-	77311	1" - 8					72611						
-	77511	1" - 12					72612						

* To complete the abbreviated part number in the table above use the prefix "217-0"

¹ Tap Drill Hole Tolerance: .234 to .500 = +.004/-0.001
Over .500 = +.005/-0.001



MS/NAS Style - 303 CRES Keylocking Threaded Inserts

Material: Inserts - 303 CRES
Keys - 302 CRES

Finish: Passivated

Tolerances: ± 0.010 inch unless specified otherwise.

Internal Threads: Per SAE AS8879

Dimensions: All dimensions below are in inches

Keys: Inserts with an internal thread size of 1/4 and larger are furnished with 4 locking keys. Smaller sizes have 2 locking keys.

Material Identification Mark: None

Lubrication: Dry Film Lube on Self-Locking Inserts only

Performance: MIL-I-45914A (MS51832)

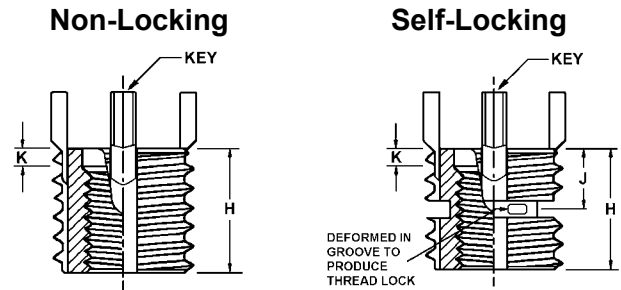

Extra Heavy Duty - Inch (See Page 3 for MS Part Number Cross Reference)

PART NUMBER*		INSERT					INSTALLATION				REMOVAL		
Non-Locking	Self-Locking	Internal Thread Class 3B	External Thread (Mod.) Class 2A	H Length	J $\pm .030$	K C'Bore Depth	Install Tool Part No.*	Tap Drill Size ¹	C'Sink Dia. $+0.010$ -0.000	Thread Tap		Drill	
										Size Class 2B	Min. Depth	Size	Depth
76333	77333	10 - 24	7/16 - 14	.312	.22	.07	72628	.397	.447	7/16 - 14	.37	11/32	3/16
76533	77533	10 - 32					72629						
76334	77334	1/4 - 20	1/2 - 13	.375	.22	.07	72630	.453	.510	1/2 - 13	.44	13/32	3/16
76534	77534	1/4 - 28					72631						
76335	77335	5/16 - 18	9/16 - 12	.437	.22	.07	72632	.516	.572	9/16 - 12	.50	15/32	3/16
76535	77535	5/16 - 24					72633						
76336	77336	3/8 - 16	5/8 - 11	.500	.25	.07	72634	.578	.635	5/8 - 11	.56	17/32	3/16
76536	77536	3/8 - 24					72635						
76337	77337	7/16 - 14	11/16-11 NS	.625	.28	.10	72636	.641	.700	11/16-11 NS	.68	19/32	3/16
76537	77537	7/16 - 20					72637						
76338	77338	1/2 - 13	13/16 - 16	.688	.28	.10	72638	.766	.822	13/16-16	.75	23/32	3/16
76538	77538	1/2 - 20					72639						
76339	77339	9/16 - 12	7/8 - 14	.812	.32	.10	72640	.828	.885	7/8 - 14	.94	25/32	3/16
76539	77539	9/16 - 18					72641						
76340	77340	5/8 - 11	1" - 12	.875	.33	.10	72642	.937	1.020	1" - 12	1.00	27/32	5/16
76540	77540	5/8 - 18					72643						
76341	-	3/4 - 10	1-1/4 - 12	1.125	-	.10	72644	1.187	1.270	1-1/4 - 12	1.31	1-3/32	5/16
76541	-	3/4 - 16					72645						
-	77341	3/4 - 10					72644						
-	77541	3/4 - 16					72645						
76342	-	7/8 - 9	1-3/8 - 12	1.250	-	.10	72646	1.312	1.395	1-3/8 - 12	1.44	1-7/32	5/16
76542	-	7/8 - 14					72647						
-	77342	7/8 - 9					72646						
-	77542	7/8 - 14					72647						
76343	-	1" - 8	1-1/2 - 12	1.375	-	.10	72648	1.437	1.520	1-1/2 - 12	1.56	1-11/32	5/16
76543	-	1" - 12					72649						
-	77343	1" - 8					72648						
-	77543	1" - 12					72649						

* To complete the abbreviated part number in the table above use the prefix "217-0"

¹ Tap Drill Hole Tolerance: .234 to .500 = $+0.004/-0.001$
Over .500 = $+0.005/-0.001$

MS/NAS Style - A286 CRES Keylocking Threaded Inserts



Material: Inserts - A286 CRES (140 KSI Min)
Keys - 302 CRES

Finish: Passivated

Tolerances: ±.010 inch unless specified otherwise

Internal Threads: Per SAE AS8879

Dimensions: All dimensions below are in inches

Keys: Miniature Inserts are furnished with 2 locking keys

Material Identification Mark: None

Lubrication: Dry Film Lube on Self-Locking Inserts only

Performance: MIL-I-45914A (MS51830)

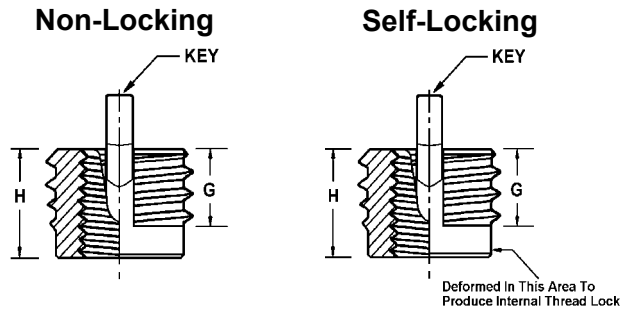

Miniature - Inch (See Page 3 for MS Part Number Cross Reference)

PART NUMBER ¹		INSERT				INSTALLATION			REMOVAL			
Non-Locking	Self-Locking	Internal Thread Class 3B	External Thread Class	G Thread Length	H Length	Install Tool Part No. ¹	Tap Drill Size +.003 -.001	C'Sink Dia. +.010 -.000	Thread Tap		Drill	
									Size Class 2B	Min. Depth	Size	Depth
78283	79283	2 - 56	8 - 32 ³	.090	.120	72552	.134	.166	8 - 32	.140	#33	1/16
78284	79284	4 - 40	10 - 32 ³	.125	.170	72554	.161	.194	10 - 32	.160	#29	3/32
78285	79285	6 - 32	12 - 28 ³	.125	.170	72556	.187	.220	12 - 28	.160	#21	3/32
78286	79286	8 - 32	1/4 - 28 ⁴	.175	.220	72558	.228	.255	1/4 - 28	.210	#8	1/8

¹ To complete the abbreviated part number in the table above use the prefix "217-0"

² Class 3A ³ Class 2A ⁴ Class 2A and Modified Minor Diameter

Material: Inserts - A286 CRES (140 KSI Min)
Keys - 302 CRES

Finish: Passivated

Tolerances: ±.010 inch unless specified otherwise.

Internal Threads: Per SAE AS8879

Dimensions: All dimensions below are in inches

Keys: Inserts with an internal thread size of 5/16 and larger are furnished with 4 locking keys. Smaller sizes have 2 locking keys.

Material Identification Mark: One line on top of Insert

Lubrication: Dry Film Lube on Self-Locking Inserts only

Performance: MIL-I-45914A (MS51830 & NAS1394)

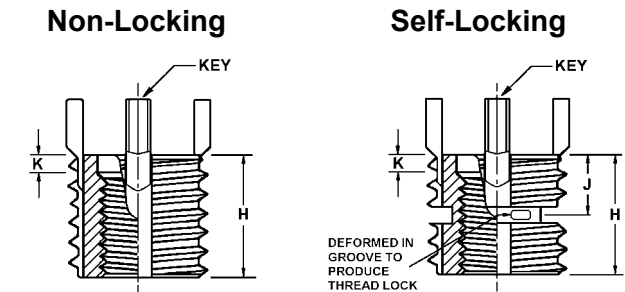

Lightweight - Inch (See Page 4 for MS/NAS Part Number Cross Reference)

PART NUMBER*		INSERT					INSTALLATION			REMOVAL			
Non-Locking	Self-Locking	Internal Thread Class 3B	External Thread (Mod.) Class 2A	H Length	J ±.030	K C'Bore Depth	Install Tool Part No.*	Tap Drill Size ¹	C'Sink Dia. +.010 -.000	Thread Tap		Drill	
										Size Class 2B	Min. Depth	Size	Depth
78321	79321	10 - 24	5/16 - 18	.312	.22	.07	72568	.272	.323	5/16 - 18	.37	7/32	5/32
78521	79521	10 - 32					72569						
78322	79322	1/4 - 20	3/8 - 16	.375	.22	.07	72570	.332	.385	3/8 - 16	.43	9/32	3/16
78522	79522	1/4 - 28					72571						
78323	79323	5/16 - 18	7/16 - 14	.437	.22	.07	72572	.397	.447	7/16 - 14	.50	11/32	3/16
78523	79523	5/16 - 24					72573						
78324	79324	3/8 - 16	1/2 - 13	.500	.24	.07	72574	.453	.510	1/2 - 13	.56	13/32	3/16
78524	79524	3/8 - 24					72575						
78325	79325	7/16 - 14	9/16 - 12	.562	.27	.07	72576	.516	.572	9/16 - 12	.62	15/32	3/16
78525	79525	7/16 - 20					72577						
78326	79326	1/2 - 13	5/8 - 11	.625	.28	.07	72578	.578	.635	5/8 - 11	.68	17/32	3/16
78526	79526	1/2 - 20					72579						

* To complete the abbreviated part number in the table above use the prefix "217-0"

¹ Tap Drill Hole Tolerance: .234 to .500 = +.004/-.001
Over .500 = +.005/-.001



MS/NAS Style - A286 CRES Keylocking Threaded Inserts

Material: Inserts - A286 CRES (140 KSI Min)
Keys - 302 CRES

Finish: Passivated

Tolerances: ±.010 inch unless specified otherwise.

Internal Threads: Per SAE AS8879

Dimensions: All dimensions below are in inches

Keys: Inserts with an internal thread size of 5/16 and larger are furnished with 4 locking keys. Smaller sizes have 2 locking keys.

Material Identification Mark: One line on top of Insert

Lubrication: Dry Film Lube on Self-Locking Inserts only

Performance: MIL-I-45914A (MS51831 & NAS1395)

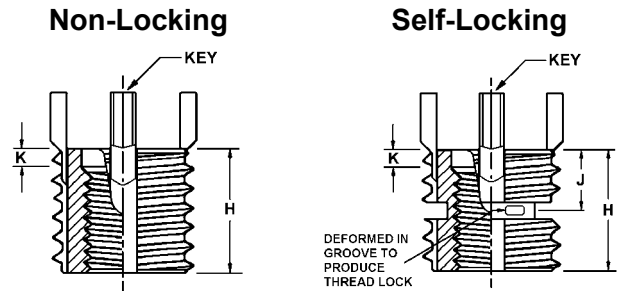

Heavy Duty - Inch (See Page 4 for MS/NAS Part Number Cross Reference)

PART NUMBER*		INSERT					INSTALLATION					REMOVAL	
Non-Locking	Self-Locking	Internal Thread Class 3B	External Thread (Mod.) Class 2A	H Length	J ± .030	K C'Bore Depth	Install Tool Part No.*	Tap Drill Size ¹	C'Sink Dia. +.010 / -.000	Thread Tap		Drill	
										Size Class 2B	Min. Depth	Size	Depth
78300	79300	8 - 32	5/16 - 18	.312	.22	.04	72590	.272	.323	5/16 - 18	.37	7/32	1/8
78301	79301	10 - 24	3/8 - 16	.312	.22	.07	72591	.332	.385	3/8 - 16	.37	9/32	1/8
78501	79501	10 - 32					72592						
78302	79302	1/4 - 20	7/16 - 14	.375	.22	.07	72593	.397	.447	7/16 - 14	.43	11/32	3/16
78502	79502	1/4 - 28					72594						
78303	79303	5/16 - 18	1/2 - 13	.437	.22	.07	72595	.453	.510	1/2 - 13	.50	13/32	3/16
78503	79503	5/16 - 24					72596						
78304	79304	3/8 - 16	9/16 - 12	.500	.25	.07	72597	.516	.572	9/16 - 12	.56	15/32	3/16
78504	79504	3/8 - 24					72598						
78305	79305	7/16 - 14	5/8 - 11	.625	.28	.10	72599	.578	.635	5/8 - 11	.68	17/32	3/16
78505	79505	7/16 - 20					72600						
78306	79306	1/2 - 13	11/16-11 NS	.688	.28	.10	72601	.641	.700	11/16-11 NS	.75	19/32	3/16
78506	79506	1/2 - 20					72602						
78307	79307	9/16 - 12	13/16 - 16	.812	.32	.10	72603	.766	.822	13/16-16	.94	23/32	3/16
78507	79507	9/16 - 18					72604						
78308	79308	5/8 - 11	7/8 - 14	.875	.33	.10	72605	.828	.885	7/8 - 14	1.00	25/32	3/16
78508	79508	5/8 - 18					72606						
78309	-	3/4 - 10	1-1/8 - 12	1.125	-	.10	72607	1.062	1.145	1-1/8 - 12	1.31	31/32	5/16
78509	-	3/4 - 16					72608						
-	79309	3/4 - 10					72607						
-	79509	3/4 - 16					72608						
78310	-	7/8 - 9	1-1/4 - 12	1.250	-	.10	72609	1.187	1.270	1-1/4 - 12	1.44	1-3/32	5/16
78510	-	7/8 - 14					72610						
-	79310	7/8 - 9					72609						
-	79510	7/8 - 14					72610						
78311	-	1" - 8	1-3/8 - 12	1.375	-	.10	72611	1.312	1.395	1-3/8 - 12	1.56	1-7/32	5/16
78511	-	1" - 12					72612						
-	79311	1" - 8					72611						
-	79511	1" - 12					72612						

* To complete the abbreviated part number in the table above use the prefix "217-0"

¹ Tap Drill Hole Tolerance: .234 to .500 = +.004/-.001
Over .500 = +.005/-.001

MS/NAS Style - A286 CRES Keylocking Threaded Inserts



Material: Inserts - A286 CRES (140 KSI Min)
Keys - 302 CRES

Finish: Passivated

Tolerances: ±.010 inch unless specified otherwise.

Internal Threads: Per SAE AS8879

Dimensions: All dimensions below are in inches

Keys: Inserts with an internal thread size of 1/4 and larger are furnished with 4 locking keys. Smaller sizes have 2 locking keys.

Material Identification Mark: One line on top of Insert

Lubrication: Dry Film Lube on Self-Locking Inserts only

Performance: MIL-I-45914A (MS51832)

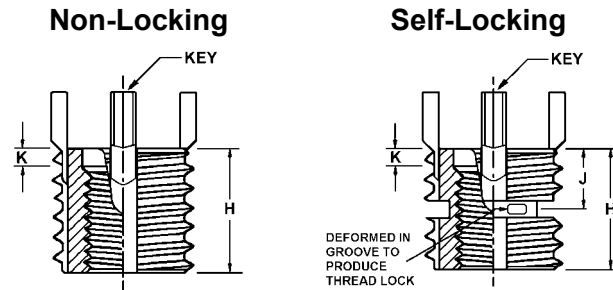

Extra Heavy Duty - Inch (See Page 4 for MS Part Number Cross Reference)

PART NUMBER*		INSERT					INSTALLATION				REMOVAL		
Non-Locking	Self-Locking	Internal Thread Class 3B	External Thread (Mod.) Class 2A	H Length	J ±.030	K C'Bore Depth	Install Tool Part No.*	Tap Drill Size ¹	C'Sink Dia. +.010 -0.000	Thread Tap Size Class 2B	Min. Depth	Drill Size	Drill Depth
78333	79333	10 - 24	7/16 - 14	.312	.22	.07	72628	.397	.447	7/16 - 14	.37	11/32	3/16
78533	79533	10 - 32					72629						
78334	79334	1/4 - 20	1/2 - 13	.375	.22	.07	72630	.453	.510	1/2 - 13	.44	13/32	3/16
78534	79534	1/4 - 28					72631						
78335	79335	5/16 - 18	9/16 - 12	.437	.22	.07	72632	.516	.572	9/16 - 12	.50	15/32	3/16
78535	79535	5/16 - 24					72633						
78336	79336	3/8 - 16	5/8 - 11	.500	.25	.07	72634	.578	.635	5/8 - 11	.56	17/32	3/16
78536	79536	3/8 - 24					72635						
78337	79337	7/16 - 14	11/16-11 NS	.625	.28	.10	72636	.641	.700	11/16-11 NS	.68	19/32	3/16
78537	79537	7/16 - 20					72637						
78338	79338	1/2 - 13	13/16 - 16	.688	.28	.10	72638	.766	.822	13/16-16	.75	23/32	3/16
78538	79538	1/2 - 20					72639						
78339	79339	9/16 - 12	7/8 - 14	.812	.32	.10	72640	.828	.885	7/8 - 14	.94	25/32	3/16
78539	79539	9/16 - 18					72641						
78340	79340	5/8 - 11	1" - 12	.875	.33	.10	72642	.937	1.020	1" - 12	1.00	27/32	5/16
78540	79540	5/8 - 18					72643						
78341	-	3/4 - 10	1-1/4 - 12	1.125	-	.10	72644	1.187	1.270	1-1/4 - 12	1.31	1-3/32	5/16
78541	-	3/4 - 16					72645						
-	79341	3/4 - 10					72644						
-	79541	3/4 - 16					72645						
78342	-	7/8 - 9	1-3/8 - 12	1.250	-	.10	72646	1.312	1.395	1-3/8 - 12	1.44	1-7/32	5/16
78542	-	7/8 - 14					72647						
-	79342	7/8 - 9					72646						
-	79542	7/8 - 14					72647						
78343	-	1" - 8	1-1/2 - 12	1.375	-	.10	72648	1.437	1.520	1-1/2 - 12	1.56	1-11/32	5/16
78543	-	1" - 12					72649						
-	79343	1" - 8					72648						
-	79543	1" - 12					72649						

* To complete the abbreviated part number in the table above use the prefix "217-0"

¹ Tap Drill Hole Tolerance: .234 to .500 = +.004/-.001
Over .500 = +.005/-.001



MS/NAS Style - 4140 Alloy Steel Keylocking Threaded Inserts

Material: Inserts - 4140 Alloy Steel (160 KSI Min)
 Keys - 302 CRES
 Finish: Cadmium Plate (QQ-P-416 Type II, Cl. 2)
 Tolerances: ±.010 inch unless specified otherwise
 Internal Threads: Per SAE AS8879
 Dimensions: All dimensions below are in inches
 Keys: Miniature Inserts are furnished with 2 locking keys
 Material Identification Mark: None
 Lubrication: Dry Film Lube on Self-Locking Inserts only
 Performance: MIL-I-45914A (MS51830)

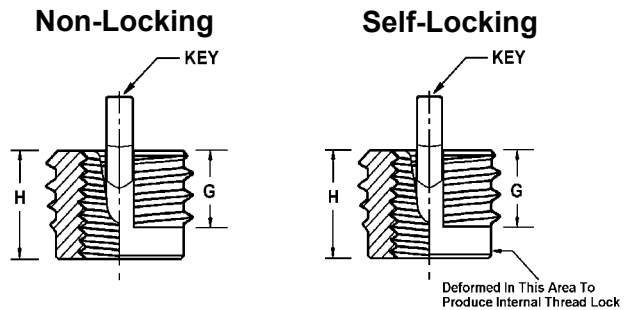

Miniature - Inch (See Page 3 for MS Part Number Cross Reference)

PART NUMBER ¹		INSERT				INSTALLATION					REMOVAL	
Non-Locking	Self-Locking	Internal Thread Class 3B	External Thread Class	G Thread Length	H Length	Install Tool Part No. ¹	Tap Drill Size +.003 -.001	C'Sink Dia. +.010 -.000	Thread Tap		Drill	
									Size Class 2B	Min. Depth	Size	Depth
80283	81283	2 - 56	8 - 32 ³	.090	.120	72552	.134	.166	8 - 32	.140	#33	1/16
80284	81284	4 - 40	10 - 32 ³	.125	.170	72554	.161	.194	10 - 32	.160	#29	3/32
80285	81285	6 - 32	12 - 28 ³	.125	.170	72556	.187	.220	12 - 28	.160	#21	3/32
80286	81286	8 - 32	1/4 - 28 ⁴	.175	.220	72558	.228	.255	1/4 - 28	.210	#8	1/8

¹ To complete the abbreviated part number in the table above use the prefix "217-0"

² Class 3A ³ Class 2A ⁴ Class 2A and Modified Minor Diameter

Material: Inserts - 4140 Alloy Steel (160 KSI Min)
 Keys - 302 CRES
 Finish: Cadmium Plate (QQ-P-416 Type II, Cl. 2)
 Tolerances: ±.010 inch unless specified otherwise.
 Internal Threads: Per SAE AS8879
 Dimensions: All dimensions below are in inches
 Keys: Inserts with an internal thread size of 5/16 and larger are furnished with 4 locking keys. Smaller sizes have 2 locking keys.
 Material Identification Mark: Two lines on top of Insert
 Lubrication: Dry Film Lube on Self-Locking Inserts only
 Performance: MIL-I-45914A (MS51830 & NAS1394)

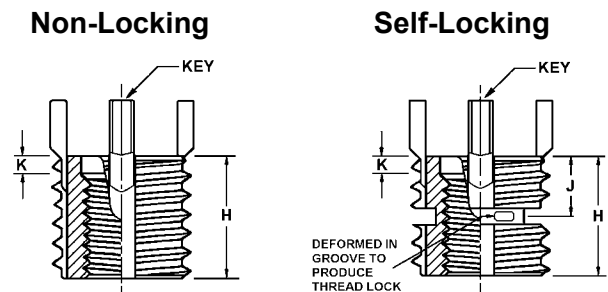

Lightweight - Inch (See Page 5 for MS/NAS Part Number Cross Reference)

PART NUMBER*		INSERT					INSTALLATION					REMOVAL	
Non-Locking	Self-Locking	Internal Thread Class 3B	External Thread (Mod.) Class 2A	H Length	J ±.030	K C'Bore Depth	Install Tool Part No.*	Tap Drill Size ¹	C'Sink Dia. +.010 -.000	Thread Tap		Drill	
										Size Class 2B	Min. Depth	Size	Depth
80321	81321	10 - 24	5/16 - 18	.312	.22	.07	72568	.272	.323	5/16 - 18	.37	7/32	5/32
80521	81521	10 - 32					72569						
80322	81322	1/4 - 20	3/8 - 16	.375	.22	.07	72570	.332	.385	3/8 - 16	.43	9/32	3/16
80522	81522	1/4 - 28					72571						
80323	81323	5/16 - 18	7/16 - 14	.437	.22	.07	72572	.397	.447	7/16 - 14	.50	11/32	3/16
80523	81523	5/16 - 24					72573						
80324	81324	3/8 - 16	1/2 - 13	.500	.24	.07	72574	.453	.510	1/2 - 13	.56	13/32	3/16
80524	81524	3/8 - 24					72575						
80325	81325	7/16 - 14	9/16 - 12	.562	.27	.07	72576	.516	.572	9/16 - 12	.62	15/32	3/16
80525	81525	7/16 - 20					72577						
80326	81326	1/2 - 13	5/8 - 11	.625	.28	.07	72578	.578	.635	5/8 - 11	.68	17/32	3/16
80526	81526	1/2 - 20					72579						

* To complete the abbreviated part number in the table above use the prefix "217-0"

¹ Tap Drill Hole Tolerance: .234 to .500 = +.004/-0.001
 Over .500 = +.005/-0.001

MS/NAS Style - 4140 Alloy Steel Keylocking Threaded Inserts



Material: Inserts - 4140 Alloy Steel (160 KSI Min)
Keys - 302 CRES

Finish: Cadmium Plate (QQ-P-416 Type II, Cl. 2)

Tolerances: ±.010 inch unless specified otherwise.

Internal Threads: Per SAE AS8879

Dimensions: All dimensions below are in inches

Keys: Inserts with an internal thread size of 5/16 and larger are furnished with 4 locking keys. Smaller sizes have 2 locking keys.

Material Identification Mark: Two lines on top of Insert

Lubrication: Dry Film Lube on Self-Locking Inserts only

Performance: MIL-I-45914A (MS51831 & NAS1395)

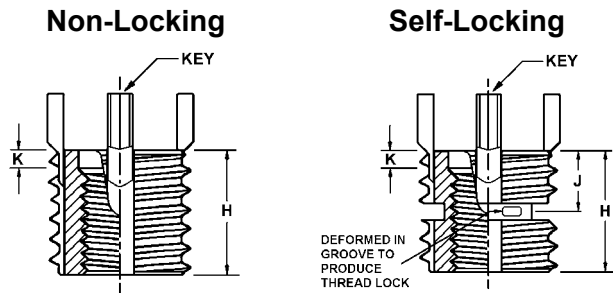

Heavy Duty - Inch (See Page 5 for MS/NAS Part Number Cross Reference)

PART NUMBER*		INSERT					INSTALLATION					REMOVAL				
Non-Locking	Self-Locking	Internal Thread Class 3B	External Thread (Mod.) Class 2A	H Length	J ±.030	K C'Bore Depth	Install Tool Part No.*	Tap Drill Size ¹	C'Sink Dia. +.010 -.000	Thread Tap		Drill				
										Size Class 2B	Min. Depth	Size	Depth			
80300	81300	8 - 32	5/16 - 18	.312	.22	.04	72590	.272	.323	5/16 - 18	.37	7/32	1/8			
80301	81301	10 - 24	3/8 - 16	.312	.22	.07	72591	.332	.385	3/8 - 16	.37	9/32	1/8			
80501	81501	10 - 32					72592									
80302	81302	1/4 - 20	7/16 - 14	.375	.22	.07	72593	.397	.447	7/16 - 14	.43	11/32	3/16			
80502	81502	1/4 - 28					72594									
80303	81303	5/16 - 18	1/2 - 13	.437	.22	.07	72595	.453	.510	1/2 - 13	.50	13/32	3/16			
80503	81503	5/16 - 24					72596									
80304	81304	3/8 - 16	9/16 - 12	.500	.25	.07	72597	.516	.572	9/16 - 12	.56	15/32	3/16			
80504	81504	3/8 - 24					72598									
80305	81305	7/16 - 14	5/8 - 11	.625	.28	.10	72599	.578	.635	5/8 - 11	.68	17/32	3/16			
80505	81505	7/16 - 20					72600									
80306	81306	1/2 - 13	11/16-11 NS	.688	.28	.10	72601	.641	.700	11/16-11 NS	.75	19/32	3/16			
80506	81506	1/2 - 20					72602									
80307	81307	9/16 - 12	13/16 - 16	.812	.32	.10	72603	.766	.822	13/16-16	.94	23/32	3/16			
80507	81507	9/16 - 18					72604									
80308	81308	5/8 - 11	7/8 - 14	.875	.33	.10	72605	.828	.885	7/8 - 14	1.00	25/32	3/16			
80508	81508	5/8 - 18					72606									
80309	-	3/4 - 10	1-1/8 - 12	1.125	-	.10	72607	1.062	1.145	1-1/8 - 12	1.31	31/32	5/16			
80509	-	3/4 - 16					72608									
-	81309	3/4 - 10					1.250							.49	.10	72607
-	81509	3/4 - 16														72608
80310	-	7/8 - 9	1-1/4 - 12	1.250	-	.10	72609	1.187	1.270	1-1/4 - 12	1.44	1-3/32	5/16			
80510	-	7/8 - 14					72610									
-	81310	7/8 - 9					1.375							.49	.10	72609
-	81510	7/8 - 14														72610
80311	-	1" - 8	1-3/8 - 12	1.375	-	.10	72611	1.312	1.395	1-3/8 - 12	1.56	1-7/32	5/16			
80511	-	1" - 12					72612									
-	81311	1" - 8					1.500							.55	.10	72611
-	81511	1" - 12														72612

* To complete the abbreviated part number in the table above use the prefix "217-0"

¹ Tap Drill Hole Tolerance: .234 to .500 = +.004/-.001
Over .500 = +.005/-.001



MS/NAS Style - 4140 Alloy Steel Keylocking Threaded Inserts

Material: Inserts - 4140 Alloy Steel (160 KSI Min)
Keys - 302 CRES

Finish: Cadmium Plate (QQ-P-416 Type II, Cl. 2)

Tolerances: ±.010 inch unless specified otherwise.

Internal Threads: Per SAE AS8879

Dimensions: All dimensions below are in inches

Keys: Inserts with an internal thread size of 1/4 and larger are furnished with 4 locking keys. Smaller sizes have 2 locking keys.

Material Identification Mark: Two lines on top of Insert

Lubrication: Dry Film Lube on Self-Locking Inserts only

Performance: MIL-I-45914A (MS51832)

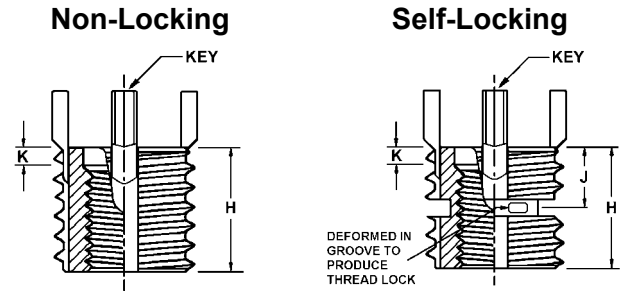

Extra Heavy Duty - Inch (See Page 5 for MS Part Number Cross Reference)

PART NUMBER*		INSERT					INSTALLATION					REMOVAL	
Non-Locking	Self-Locking	Internal Thread Class 3B	External Thread (Mod.) Class 2A	H Length	J ±.030	K C'Bore Depth	Install Tool Part No.*	Tap Drill Size ¹	C'Sink Dia. +.010/-000	Thread Tap		Drill	
										Size Class 2B	Min. Depth	Size	Depth
80333	81333	10 - 24	7/16 - 14	.312	.22	.07	72628	.397	.447	7/16 - 14	.37	11/32	3/16
80533	81533	10 - 32					72629						
80334	81334	1/4 - 20	1/2 - 13	.375	.22	.07	72630	.453	.510	1/2 - 13	.44	13/32	3/16
80534	81534	1/4 - 28					72631						
80335	81335	5/16 - 18	9/16 - 12	.437	.22	.07	72632	.516	.572	9/16 - 12	.50	15/32	3/16
80535	81535	5/16 - 24					72633						
80336	81336	3/8 - 16	5/8 - 11	.500	.25	.07	72634	.578	.635	5/8 - 11	.56	17/32	3/16
80536	81536	3/8 - 24					72635						
80337	81337	7/16 - 14	11/16-11 NS	.625	.28	.10	72636	.641	.700	11/16-11 NS	.68	19/32	3/16
80537	81537	7/16 - 20					72637						
80338	81338	1/2 - 13	13/16 - 16	.688	.28	.10	72638	.766	.822	13/16-16	.75	23/32	3/16
80538	81538	1/2 - 20					72639						
80339	81339	9/16 - 12	7/8 - 14	.812	.32	.10	72640	.828	.885	7/8 - 14	.94	25/32	3/16
80539	81539	9/16 - 18					72641						
80340	81340	5/8 - 11	1" - 12	.875	.33	.10	72642	.937	1.020	1" - 12	1.00	27/32	5/16
80540	81540	5/8 - 18					72643						
80341	-	3/4 - 10	1-1/4 - 12	1.125	-	.10	72644	1.187	1.270	1-1/4 - 12	1.31	1-3/32	5/16
80541	-	3/4 - 16					72645						
-	81341	3/4 - 10					72644						
-	81541	3/4 - 16					72645						
80342	-	7/8 - 9	1-3/8 - 12	1.250	-	.10	72646	1.312	1.395	1-3/8 - 12	1.44	1-7/32	5/16
80542	-	7/8 - 14					72647						
-	81342	7/8 - 9					72646						
-	81542	7/8 - 14					72647						
80343	-	1" - 8	1-1/2 - 12	1.375	-	.10	72648	1.437	1.520	1-1/2 - 12	1.56	1-11/32	5/16
80543	-	1" - 12					72649						
-	81343	1" - 8					72648						
-	81543	1" - 12					72649						

* To complete the abbreviated part number in the table above use the prefix "217-0"

¹ Tap Drill Hole Tolerance: .234 to .500 = +.004/-001
Over .500 = +.005/-001

MS/NAS Style - 303 CRES Keylocking Threaded Inserts



Material: Inserts - 303 CRES
Keys - 302 CRES

Finish: Passivated

Tolerances: $\pm .25$ mm unless specified otherwise

Internal Threads: Per Fed Std H28/21, MJ Form

Dimensions: All dimensions below are in millimeters

Keys: Miniature Inserts are furnished with 2 locking keys

Material Identification Mark: None

Lubrication: Dry Film Lube on Self-Locking Inserts only

Performance: See note on the bottom of page 17

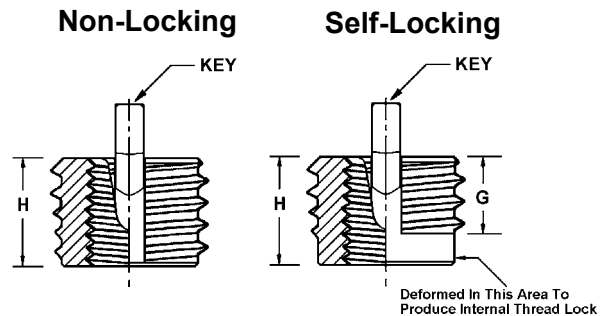

Miniature - Metric

PART NUMBER*		INSERT				INSTALLATION					REMOVAL	
Non-Locking	Self-Locking	Internal Thread Class 4H6H	External Thread Class 4h	G Thread Length	H Length	Install Tool Part No.*	Tap Drill Size $+0.080$ -0.025	C'Sink Dia. $+0.25$ -0.00	Thread Tap		Drill	
									Size Class 6H	Min. Depth	Size	Depth
76382	77382	M 2x0.4	M 4x0.7	2.20	3.00	72682	3.4	4.1	M 4x0.7	4.0	2.8	2.00
76383	77383	M 2.5x0.45	M 4.5x0.75	2.70	3.81	72683	3.9	4.6	M 4.5x0.75	5.0	3.0	2.00
76384	77384	M 3x0.5	M 5x0.8	3.10	4.25	72684	4.4	5.1	M 5x0.8	5.5	3.5	2.25
76386	77386	M 4x0.7	M 6x0.75	4.11	5.25	72686	5.5	6.1	M 6x0.75	6.5	4.6	2.50

* To complete the abbreviated part numbers in the table above use the prefix "217-0"

Material: Inserts - 303 CRES
Keys - 302 CRES

Finish: Passivated

Tolerances: $\pm .25$ mm unless specified otherwise.

Internal Threads: Per Fed Std H28/21, MJ Form

Dimensions: All dimensions below are in millimeters

Keys: Inserts with an internal thread size of M 6 and smaller are furnished with 2 locking keys. Larger sizes have 4 locking keys.

Material Identification Mark: None

Lubrication: Dry Film Lube on Self-Locking Inserts only

Performance: See note on the bottom of page 17

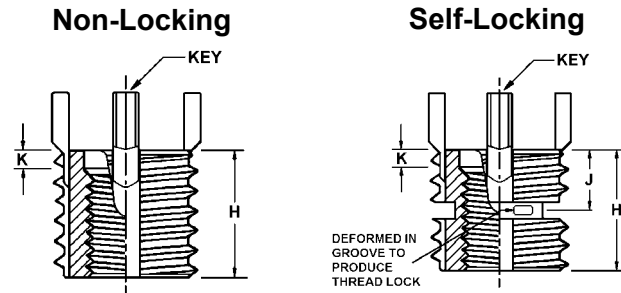

Lightweight - Metric

PART NUMBER*		INSERT					INSTALLATION					REMOVAL	
Non-Locking	Self-Locking	Internal Thread ¹ Class 4H5H	External Thread Class 4h	H Length	J $\pm .76$	K C'Bore Depth	Install Tool Part No.*	Tap Drill Size ²	C'Sink Dia. $+0.25$ -0.00	Thread Tap		Drill	
										Size Class 6H	Min. Depth	Size	Depth
76351	77351	M 5x0.8	M 8x1.25	8.0	3.73	1.27	72651	6.90	8.25	M 8x1.25	9.5	5.50	4.00
76551	77551	M 5x0.5											
76352	77352	M 6x1.0	M 10x1.25	10.0	6.02	1.78	72652	8.80	10.25	M 10x1.25	11.5	7.50	4.75
76552	77552	M 6x0.75											
76353	77353	M 8x1.25	M 12x1.25	12.0	6.28	1.78	72653	10.80	12.25	M 12x1.25	13.5	9.50	4.75
76553	77553	M 8x1.0											
76355	77355	M 10x1.5	M 14x1.5	14.0	6.46	2.29	72655	12.80	14.25	M 14x1.5	15.5	11.50	4.75
76555	77555	M 10x1.25											
76356	77356	M 12x1.75	M 16x1.5	16.0	6.46	2.29	72656	14.75	16.25	M 16x1.5	17.5	13.50	4.75
76556	77556	M 12x1.25											

* To complete the abbreviated part numbers in the table above use the prefix "217-0"

¹ Thread Class on M 5 Internal Thread is 4H6H

² Tap Drill Hole Tolerance: 6.90 to 10.80 = $+0.100/-0.025$
Over 12.80 = $+0.130/-0.025$



MS/NAS Style - 303 CRES Keylocking Threaded Inserts

Material: Inserts - 303 CRES
Keys - 302 CRES

Finish: Passivated

Tolerances: $\pm .25$ mm unless specified otherwise.

Internal Threads: Per Fed Std H28/21, MJ Form

Dimensions: All dimensions below are in millimeters

Keys: Inserts with an internal thread size of M 6 and smaller are furnished with 2 locking keys. Larger sizes have 4 locking keys.

Material Identification Mark: None

Lubrication: Dry Film Lube on Self-Locking Inserts only

Performance: See note on the bottom of this page

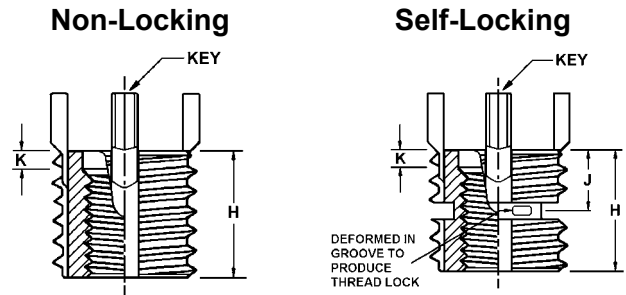

Heavy Duty - Metric

PART NUMBER*		INSERT					INSTALLATION					REMOVAL	
Non-Locking	Self-Locking	Internal Thread ¹ Class 4H5H	External Thread Class 4h	H Length	J $\pm .76$	K C'Bore Depth	Install Tool Part No.*	Tap Drill Size ²	C'Sink Dia. $+ .25$ $- .00$	Thread Tap		Drill	
										Size Class 6H	Min. Depth	Size	Depth
76363	77363	M 4x0.7	M 8x1.25	8.0	5.00	1.27	72663	6.90	8.25	M 8x1.25	9.5	5.50	4.00
76364	77364	M 5x0.8	M 10x1.25	10.0	5.50	1.27	72664	8.80	10.25	M 10x1.25	12.5	7.50	4.75
76365	77365	M 6x1.0	M 12x1.25	12.0	6.46	1.78	72665	10.80	12.25	M 12x1.25	14.5	9.50	4.75
76366	77366	M 8x1.25	M 14x1.5	14.0	6.46	1.78	72666	12.80	14.25	M 14x1.5	16.5	11.50	4.75
76566	77566	M 8x1.0											
76367	77367	M 10x1.5	M 16x1.5	16.0	6.46	2.29	72667	14.75	16.25	M 16x1.5	18.5	13.50	4.75
76567	77567	M 10x1.25											
76369	77369	M 12x1.75	M 18x1.5	18.0	7.23	2.29	72669	16.75	18.25	M 18x1.5	20.5	15.50	4.75
76569	77569	M 12x1.25											
76370	77370	M 14x2.0	M 20x1.5	20.0	7.73	2.79	72670	18.75	20.25	M 20x1.5	22.5	17.50	4.75
76570	77570	M 14x1.5											
76371	77371	M 16x2.0	M 22x1.5	22.0	8.50	2.79	72671	20.50	22.25	M 22x1.5	24.5	17.75	6.35
76571	77571	M 16x1.5											
76572	77572	M 18x1.5	M 24x2.0	24.0	9.25	2.79	72672	22.50	24.25	M 24x2.0	28.5	19.75	6.35
76373	77373	M 20x2.5	M 30x2.0	30.0	12.51	2.79	72673	28.00	30.25	M 30x2.0	34.5	25.75	6.35
76573	77573	M 20x1.5											
76574	77574	M 22x1.5	M 32x2.0	32.0	12.51	2.79	72674	30.00	32.25	M 32x2.0	36.5	27.75	6.35
76375	77375	M 24x3.0	M 33x2.0	33.0	13.97	3.81	72675	31.00	33.25	M 33x2.0	37.5	28.75	6.35
76575	77575	M 24x2.0											

* To complete the abbreviated part numbers in the table above use the prefix "217-0"

¹ Thread Class on M 4 and M 5 Internal Thread is 4H6H

² Tap Drill Hole Tolerance: 6.90 to 10.80 = $+0.100/-0.025$
Over 12.80 = $+0.130/-0.025$

Note: There is no National Aerospace Standard for Metric Keylocking Inserts manufactured from 303 CRES. The inserts shown on pages 16 and 17 are compliant with the other requirements of NA0147, NA0149, and NA0151 except for any references to the type of material or performance related to the material.

MS/NAS Style - A286 CRES Keylocking Threaded Inserts



Material: Inserts - A286 CRES (140 KSI Min)
Keys - 302 CRES

Finish: Passivated

Tolerances: $\pm .25$ mm unless specified otherwise

Internal Threads: Per Fed Std H28/21, MJ Form

Dimensions: All dimensions below are in millimeters

Keys: Miniature Inserts are furnished with 2 locking keys

Material Identification Mark: None

Lubrication: Dry Film Lube on Self-Locking Inserts only

Performance: NA0147

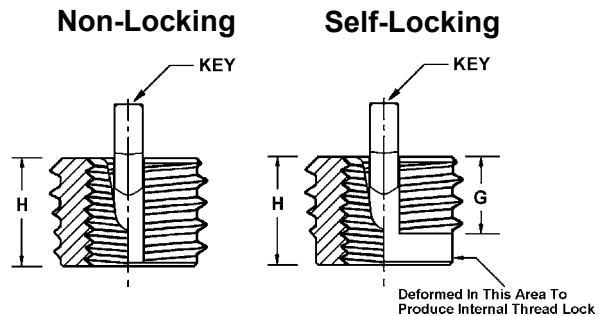

Miniature - Metric (See Top of Page 6 for NA Part Number Cross Reference)

PART NUMBER*		INSERT				INSTALLATION					REMOVAL	
Non-Locking	Self-Locking	Internal Thread Class 4H6H	External Thread Class 4h	G Thread Length	H Length	Install Tool Part No.*	Tap Drill Size $+0.080$ -0.025	C'Sink Dia. $+0.25$ -0.00	Thread Tap		Drill	
									Size Class 6H	Min. Depth	Size	Depth
78382	79382	M 2x0.4	M 4x0.7	2.20	3.00	72682	3.4	4.1	M 4x0.7	4.0	2.8	2.00
78383	79383	M 2.5x0.45	M 4.5x0.75	2.70	3.81	72683	3.9	4.6	M 4.5x0.75	5.0	3.0	2.00
78384	79384	M 3x0.5	M 5x0.8	3.10	4.25	72684	4.4	5.1	M 5x0.8	5.5	3.5	2.25
78386	79386	M 4x0.7	M 6x0.75	4.11	5.25	72686	5.5	6.1	M 6x0.75	6.5	4.6	2.50

* To complete the abbreviated part numbers in the table above use the prefix "217-0"

Material: Inserts - A286 CRES (140 KSI Min)
Keys - 302 CRES

Finish: Passivated

Tolerances: $\pm .25$ mm unless specified otherwise.

Internal Threads: Per Fed Std H28/21, MJ Form

Dimensions: All dimensions below are in millimeters

Keys: Inserts with an internal thread size of M 6 and smaller are furnished with 2 locking keys. Larger sizes have 4 locking keys.

Material Identification Mark: One line on top of Insert

Lubrication: Dry Film Lube on Self-Locking Inserts only

Performance: NA0149

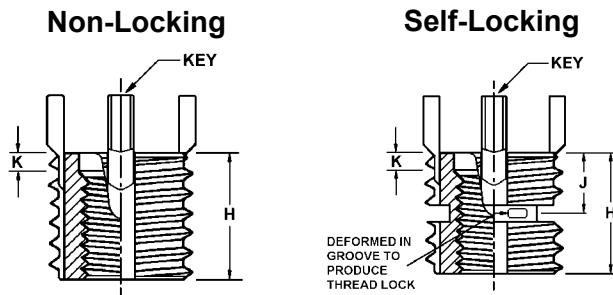

Lightweight - Metric (See Top of Page 6 for NA Part Number Cross Reference)

PART NUMBER*		INSERT					INSTALLATION					REMOVAL	
Non-Locking	Self-Locking	Internal Thread ¹ Class 4H5H	External Thread Class 4h	H Length	J $\pm .76$	K C'Bore Depth	Install Tool Part No.*	Tap Drill Size ²	C'Sink Dia. $+0.25$ -0.00	Thread Tap		Drill	
										Size Class 6H	Min. Depth	Size	Depth
78351	79351	M 5x0.8	M 8x1.25	8.0	3.73	1.27	72651	6.90	8.25	M 8x1.25	9.5	5.50	4.00
78551	79551	M 5x0.5											
78352	79352	M 6x1.0	M 10x1.25	10.0	6.02	1.78	72652	8.80	10.25	M 10x1.25	11.5	7.50	4.75
78552	79552	M 6x0.75											
78353	79353	M 8x1.25	M 12x1.25	12.0	6.28	1.78	72653	10.80	12.25	M 12x1.25	13.5	9.50	4.75
78553	79553	M 8x1.0											
78355	79355	M 10x1.5	M 14x1.5	14.0	6.46	2.29	72655	12.80	14.25	M 14x1.5	15.5	11.50	4.75
78555	79555	M 10x1.25											
78356	79356	M 12x1.75	M 16x1.5	16.0	6.46	2.29	72656	14.75	16.25	M 16x1.5	17.5	13.50	4.75
78556	79556	M 12x1.25											

* To complete the abbreviated part numbers in the table above use the prefix "217-0"

¹ Thread Class on M 5 Internal Thread is 4H6H

² Tap Drill Hole Tolerance: 6.90 to 10.80 = $+0.100/-0.025$
Over 12.80 = $+0.130/-0.025$



MS/NAS Style - A286 CRES Keylocking Threaded Inserts

Material: Inserts - A286 CRES (140 KSI Min)
Keys - 302 CRES

Finish: Passivated

Tolerances: $\pm .25$ mm unless specified otherwise.

Internal Threads: Per Fed Std H28/21, MJ Form

Dimensions: All dimensions below are in millimeters

Keys: Inserts with an internal thread size of M 6 and smaller are furnished with 2 locking keys. Larger sizes have 4 locking keys.

Material Identification Mark: One line on top of Insert

Lubrication: Dry Film Lube on Self-Locking Inserts only

Performance: NA0151

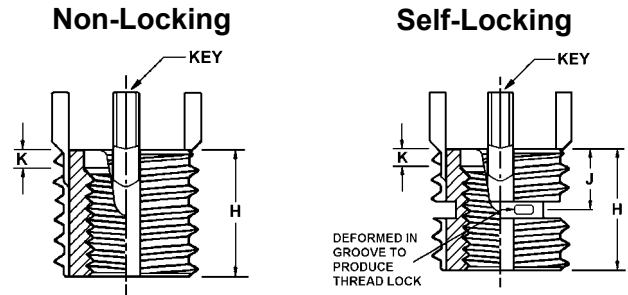

Heavy Duty - Metric (See Top of Page 6 for NA Part Number Cross Reference)

PART NUMBER*		INSERT					INSTALLATION					REMOVAL	
Non-Locking	Self-Locking	Internal Thread ¹ Class 4H5H	External Thread Class 4h	H Length	J $\pm .76$	K C'Bore Depth	Install Tool Part No.*	Tap Drill Size ²	C'Sink Dia. $+ .25$ $- .00$	Thread Tap		Drill	
										Size Class 6H	Min. Depth	Size	Depth
78363	79363	M 4x0.7	M 8x1.25	8.0	5.00	1.27	72663	6.90	8.25	M 8x1.25	9.5	5.50	4.00
78364	79364	M 5x0.8	M 10x1.25	10.0	5.50	1.27	72664	8.80	10.25	M 10x1.25	12.5	7.50	4.75
78365	79365	M 6x1.0	M 12x1.25	12.0	6.46	1.78	72665	10.80	12.25	M 12x1.25	14.5	9.50	4.75
78366	79366	M 8x1.25	M 14x1.5	14.0	6.46	1.78	72666	12.80	14.25	M 14x1.5	16.5	11.50	4.75
78566	79566	M 8x1.0											
78367	79367	M 10x1.5	M 16x1.5	16.0	6.46	2.29	72667	14.75	16.25	M 16x1.5	18.5	13.50	4.75
78567	79567	M 10x1.25											
78369	79369	M 12x1.75	M 18x1.5	18.0	7.23	2.29	72669	16.75	18.25	M 18x1.5	20.5	15.50	4.75
78569	79569	M 12x1.25											
78370	79370	M 14x2.0	M 20x1.5	20.0	7.73	2.79	72670	18.75	20.25	M 20x1.5	22.5	17.50	4.75
78570	79570	M 14x1.5											
78371	79371	M 16x2.0	M 22x1.5	22.0	8.50	2.79	72671	20.50	22.25	M 22x1.5	24.5	17.75	6.35
78571	79571	M 16x1.5											
78572	79572	M 18x1.5	M 24x2.0	24.0	9.25	2.79	72672	22.50	24.25	M 24x2.0	28.5	19.75	6.35
78373	79373	M 20x2.5											
78573	79573	M 20x1.5	M 30x2.0	30.0	12.51	2.79	72673	28.00	30.25	M 30x2.0	34.5	25.75	6.35
78574	79574	M 22x1.5											
78375	79375	M 24x3.0	M 33x2.0	33.0	13.97	3.81	72675	31.00	33.25	M 33x2.0	37.5	28.75	6.35
78575	79575	M 24x2.0											

* To complete the abbreviated part numbers in the table above use the prefix "217-0"

¹ Thread Class on M 4 and M 5 Internal Thread is 4H6H

² Tap Drill Hole Tolerance: 6.90 to 10.80 = $+0.100/-0.025$
Over 12.80 = $+0.130/-0.025$

MS/NAS Style - 4140 Alloy Steel Keylocking Threaded Inserts



Material: Inserts - 4140 Alloy Steel (160 KSI Min)
Keys - 302 CRES

Finish: Cadmium Plate (QQ-P-416 Type II, Cl. 2)

Tolerances: ±.25 mm unless specified otherwise

Internal Threads: Per Fed Std H28/21, MJ Form

Dimensions: All dimensions below are in millimeters

Keys: Miniature Inserts are furnished with 2 locking keys

Material Identification Mark: None

Lubrication: Dry Film Lube on Self-Locking Inserts only

Performance: NA0146

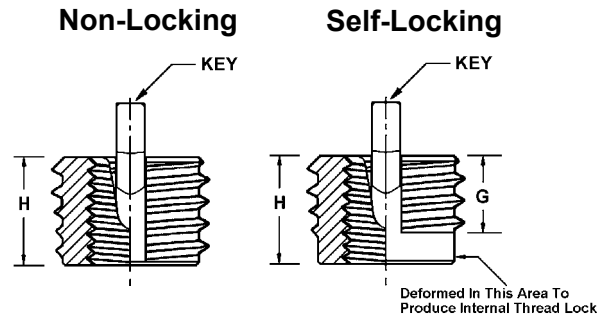

Miniature - Metric (See Bottom of Page 6 for NA Part Number Cross Reference)

PART NUMBER*		INSERT				INSTALLATION					REMOVAL	
Non-Locking	Self-Locking	Internal Thread Class 4H6H	External Thread Class 4h	G Thread Length	H Length	Install Tool Part No.*	Tap Drill Size $+0.08$ -0.25	C'Sink Dia. $+0.25$ -0.00	Thread Tap		Drill	
									Size Class 6H	Min. Depth	Size	Depth
80382	81382	M 2x0.4	M 4x0.7	2.20	3.00	72682	3.4	4.1	M 4x0.7	4.0	2.8	2.00
80383	81383	M 2.5x0.45	M 4.5x0.75	2.70	3.81	72683	3.9	4.6	M 4.5x0.75	5.0	3.0	2.00
80384	81384	M 3x0.5	M 5x0.8	3.10	4.25	72684	4.4	5.1	M 5x0.8	5.5	3.5	2.25
80386	81386	M 4x0.7	M 6x0.75	4.11	5.25	72686	5.5	6.1	M 6x0.75	6.5	4.6	2.50

* To complete the abbreviated part numbers in the table above use the prefix "217-0"

Material: Inserts - 4140 Alloy Steel (160 KSI Min)
Keys - 302 CRES

Finish: Cadmium Plate (QQ-P-416 Type II, Cl. 2)

Tolerances: ±.25 mm unless specified otherwise.

Internal Threads: Per Fed Std H28/21, MJ Form

Dimensions: All dimensions below are in millimeters

Keys: Inserts with an internal thread size of M 6 and smaller are furnished with 2 locking keys. Larger sizes have 4 locking keys.

Material Identification Mark: Two lines on top of Insert

Lubrication: Dry Film Lube on Self-Locking Inserts only

Performance: NA0148

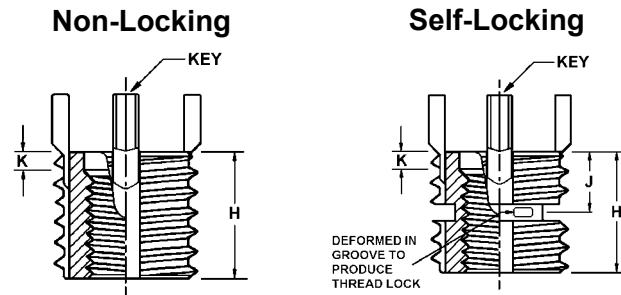

Lightweight - Metric (See Bottom of Page 6 for NA Part Number Cross Reference)

PART NUMBER*		INSERT					INSTALLATION					REMOVAL	
Non-Locking	Self-Locking	Internal Thread ¹ Class 4H5H	External Thread Class 4h	H Length	J ±.76	K C'Bore Depth	Install Tool Part No.*	Tap Drill Size ²	C'Sink Dia. $+0.25$ -0.00	Thread Tap		Drill	
										Size Class 6H	Min. Depth	Size	Depth
80351	81351	M 5x0.8	M 8x1.25	8.0	3.73	1.27	72651	6.90	8.25	M 8x1.25	9.5	5.50	4.00
80551	81551	M 5x0.5											
80352	81352	M 6x1.0	M 10x1.25	10.0	6.02	1.78	72652	8.80	10.25	M 10x1.25	11.5	7.50	4.75
80552	81552	M 6x0.75											
80353	81353	M 8x1.25	M 12x1.25	12.0	6.28	1.78	72653	10.80	12.25	M 12x1.25	13.5	9.50	4.75
80553	81553	M 8x1.0											
80355	81355	M 10x1.5	M 14x1.5	14.0	6.46	2.29	72655	12.80	14.25	M 14x1.5	15.5	11.50	4.75
80555	81555	M 10x1.25											
80356	81356	M 12x1.75	M 16x1.5	16.0	6.46	2.29	72656	14.75	16.25	M 16x1.5	17.5	13.50	4.75
80556	81556	M 12x1.25											

* To complete the abbreviated part numbers in the table above use the prefix "217-0"

¹ Thread Class on M 5 Internal Thread is 4H6H

² Tap Drill Hole Tolerance: 6.90 to 10.80 = +0.100/-0.025
Over 12.80 = +0.130/-0.025



MS/NAS Style - 4140 Alloy Steel Keylocking Threaded Inserts

Material: Inserts - 4140 Alloy Steel (160 KSI Min)
Keys - 302 CRES

Finish: Cadmium Plate (QQ-P-416 Type II, Cl. 2)

Tolerances: $\pm .25$ mm unless specified otherwise.

Internal Threads: Per Fed Std H28/21, MJ Form

Dimensions: All dimensions below are in millimeters

Keys: Inserts with an internal thread size of M 6
and smaller are furnished with 2 locking keys.
Larger sizes have 4 locking keys.

Material Identification Mark: Two lines on top of Insert

Lubrication: Dry Film Lube on Self-Locking Inserts only

Performance: NA0150

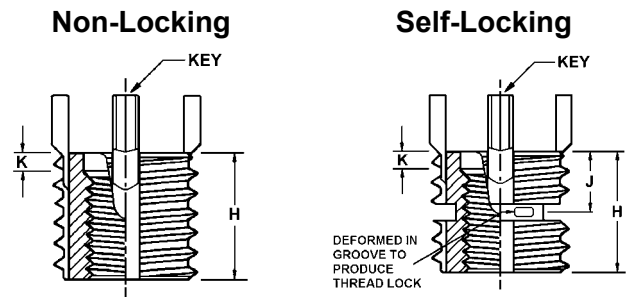

Heavy Duty - Metric (See Bottom of Page 6 for NA Part Number Cross Reference)

PART NUMBER*		INSERT					INSTALLATION					REMOVAL	
Non-Locking	Self-Locking	Internal Thread ¹ Class 4H5H	External Thread Class 4h	H Length	J $\pm .76$	K C'Bore Depth	Install Tool Part No.*	Tap Drill Size ²	C'Sink Dia. $+ .25$ $- .00$	Thread Tap		Drill	
										Size Class 6H	Min. Depth	Size	Depth
80363	81363	M 4x0.7	M 8x1.25	8.0	5.00	1.27	72663	6.90	8.25	M 8x1.25	9.5	5.50	4.00
80364	81364	M 5x0.8	M 10x1.25	10.0	5.50	1.27	72664	8.80	10.25	M 10x1.25	12.5	7.50	4.75
80365	81365	M 6x1.0	M 12x1.25	12.0	6.46	1.78	72665	10.80	12.25	M 12x1.25	14.5	9.50	4.75
80366	81366	M 8x1.25	M 14x1.5	14.0	6.46	1.78	72666	12.80	14.25	M 14x1.5	16.5	11.50	4.75
80566	81566	M 8x1.0											
80367	81367	M 10x1.5	M 16x1.5	16.0	6.46	2.29	72667	14.75	16.25	M 16x1.5	18.5	13.50	4.75
80567	81567	M 10x1.25											
80369	81369	M 12x1.75	M 18x1.5	18.0	7.23	2.29	72669	16.75	18.25	M 18x1.5	20.5	15.50	4.75
80569	81569	M 12x1.25											
80370	81370	M 14x2.0	M 20x1.5	20.0	7.73	2.79	72670	18.75	20.25	M 20x1.5	22.5	17.50	4.75
80570	81570	M 14x1.5											
80371	81371	M 16x2.0	M 22x1.5	22.0	8.50	2.79	72671	20.50	22.25	M 22x1.5	24.5	17.75	6.35
80571	81571	M 16x1.5											
80572	81572	M 18x1.5	M 24x2.0	24.0	9.25	2.79	72672	22.50	24.25	M 24x2.0	28.5	19.75	6.35
80373	81373	M 20x2.5											
80573	81573	M 20x1.5	M 30x2.0	30.0	12.51	2.79	72673	28.00	30.25	M 30x2.0	34.5	25.75	6.35
80574	81574	M 22x1.5	M 32x2.0	32.0	12.51	2.79	72674	30.00	32.25	M 32x2.0	36.5	27.75	6.35
80375	81375	M 24x3.0	M 33x2.0	33.0	13.97	3.81	72675	31.00	33.25	M 33x2.0	37.5	28.75	6.35
80575	81575	M 24x2.0											

* To complete the abbreviated part numbers in the table above use the prefix "217-0"

¹ Thread Class on M 4 and M 5 Internal Thread is 4H6H

² Tap Drill Hole Tolerance: 6.90 to 10.80 = $+0.100/-0.025$
Over 12.80 = $+0.130/-0.025$

NAS Style - 303 CRES Integral Key Inserts (NAS1394 and NAS1395)



Material: 303 CRES
 Finish: Passivated
 Tolerances: ± 0.010 inch unless specified otherwise
 Internal Threads: Per SAE AS8879
 Dimensions: All dimensions below are in inches
 Keys: Integral key inserts are furnished with 2 locking keys
 Material Identification Mark: None
 Lubrication: Dry Film Lube on Self-Locking Inserts only
 Performance: MIL-I-45914 (NAS1394 and NAS1395)

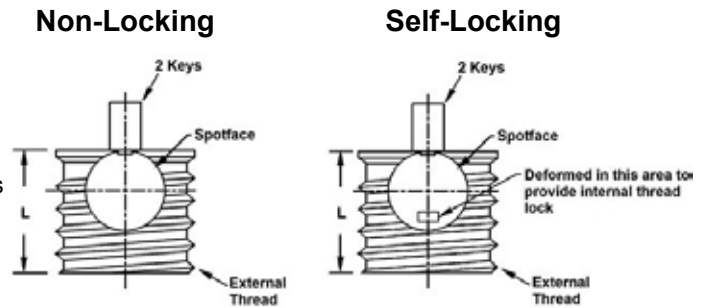

Non-Locking			Self-Locking			Dimensions			
NAS #	ACME PART NUMBER	Install Tool Part #	NAS #	ACME PART NUMBER	Install Tool Part #	Internal Thread Class 3B	External Thread Class 2A	L	Maximum Distance from Top of Part to Locking Feature
NAS1394C08	217-076288	72860/72560	NAS1394C08L	217-077288	72860/72760	8-32 UNJC	1/4-20 UNC	.25	.109
NAS1395C04	217-076290	72864/72564	NAS1395C04L	217-077290	72864/72764	4-40 UNJC	12-24 NC	.25	.109
NAS1395C06	217-076291	72860/72566	NAS1395C06L	217-077291	72860/72766	6-32 UNJC	1/4-20 UNC	.25	.109

NAS Style - 286 CRES Integral Key Inserts (NAS1394 and NAS1395)

Material: 286 CRES (140 KSI min)
 Finish: Passivated
 Tolerances: ± 0.010 inch unless specified otherwise
 Internal Threads: Per SAE AS8879
 Dimensions: All dimensions below are in inches
 Keys: Integral key inserts are furnished with 2 locking keys
 Material Identification Mark: None
 Lubrication: Dry Film Lube on Self-Locking Inserts only
 Performance: MIL-I-45914 (NAS1394 and NAS1395)

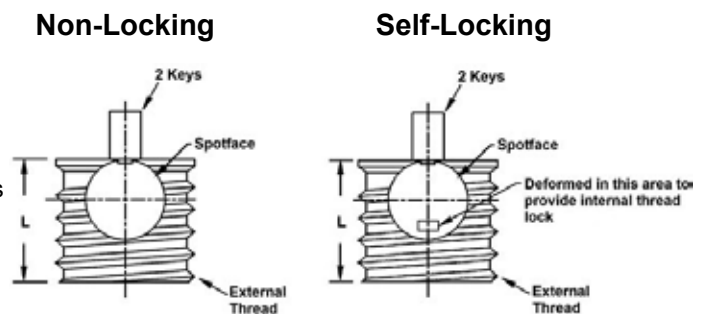

Non-Locking			Self-Locking			Dimensions			
NAS #	ACME PART NUMBER	Install Tool Part #	NAS #	ACME PART NUMBER	Install Tool Part #	Internal Thread Class 3B	External Thread Class 2A	L	Maximum Distance from Top of Part to Locking Feature
NAS1394CA08	217-078288	72860/72560	NAS1394CA08L	217-079288	72860/72760	8-32 UNJC	1/4-20 UNC	.25	.109
NAS1395CA04	217-078290	72864/72564	NAS1395CA04L	217-079290	72864/72764	4-40 UNJC	12-24 NC	.25	.109
NAS1395CA06	217-078291	72860/72566	NAS1395CA06L	217-079291	72860/72766	6-32 UNJC	1/4-20 UNC	.25	.109



NAS Style - 4140 CRES Integral Key Inserts (NAS1394 and NAS1395)

Material: 4140 Alloy Steel (160 KSI Min)
 Finish: Cadmium Plate (QQ-P-416 Type II, Cl. 2)
 Tolerances: ±.010 inch unless specified otherwise
 Internal Threads: Per SAE AS8879
 Dimensions: All dimensions below are in inches
 Keys: Integral key inserts are furnished with 2 locking keys
 Material Identification Mark: None
 Lubrication: Dry Film Lube on Self-Locking Inserts only
 Performance: MIL-I-45914 (NAS1394 and NAS1395)

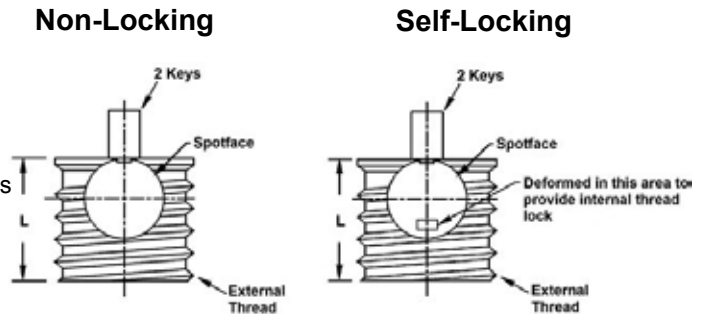

Non-Locking			Self-Locking			Dimensions			
NAS #	ACME PART NUMBER	Install Tool Part #	NAS #	ACME PART NUMBER	Install Tool Part #	Internal Thread Class 3B	External Thread Class 2A	L	Maximum Distance from Top of Part to Locking Feature
NAS1394-08	217-080288	72860/72560	NAS1394-08L	217-081288	72860/72760	8-32 UNJC	1/4-20 UNC	.25	.109
NAS1395-04	217-080290	72864/72564	NAS1395-04L	217-081290	72864/72764	4-40 UNJC	12-24 NC	.25	.109
NAS1395-06	217-080291	72860/72566	NAS1395-06L	217-081291	72860/72766	6-32 UNJC	1/4-20 UNC	.25	.109

Integral Key Installation

PART NUMBER	TAP DRILL DIA.	C'DRILL DIA.	TAP THREAD	
			SIZE UNC-2B	MIN. DEPTH
217-076288	0.213	1/4" Dia. X .030/.040 Depth	1/4-20	.31
217-077288				
217-078288				
217-079288				
217-080288				
217-081288				
217-076290	0.180	7/32" Dia. X .030/.040 Depth	12-24	.31
217-077290				
217-078290				
217-079290				
217-080290				
217-081290				
217-076291	0.213	1/4" Dia. X .030/.040 Depth	1/4-20	.31
217-077291				
217-078291				
217-079291				
217-080291				
217-081291				

Specific Use - Blind End Keylocking Threaded Inserts



Material: Inserts - 303 CRES
Keys - 302 CRES

Finish: Passivated

Tolerances: $\pm .010$ inch unless specified otherwise.

Internal Threads: Per SAE AS8879

Dimensions: All dimensions below are in inches

Keys: Inserts with an internal thread size of 5/16 and larger are furnished with 4 locking keys. Smaller sizes have 2 locking keys.

Material Identification Mark: None

Lubrication: Dry Film Lube on Self-Locking Inserts only

Performance: MIL-I-45914A

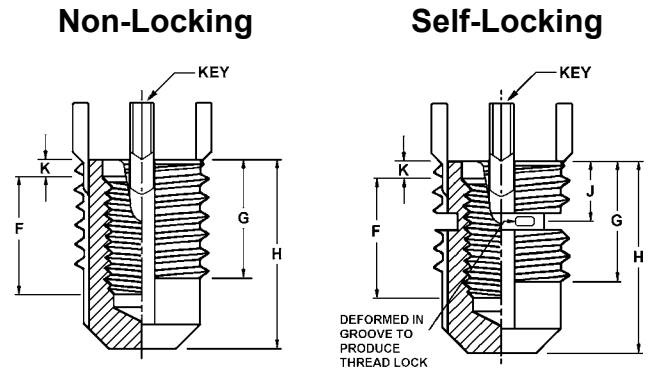

Miniature - Inch

PART NUMBER*		INSERT							INSTALLATION					REMOVAL	
Non-Lock	Self-Lock	Internal Thread Class 3B	External Thread Class 2A	F Int Thd (min)	G Ext Thd	H Lgth	J $\pm .030$	K C'Bore Depth	Install Tool Part No.*	Tap Drill Size ¹	C'Sink Dia. $+.010$ $-.000$	Thread Tap		Drill	
												Size Class 2B	Min. Depth	Size	Depth
83290	84290	2 - 56	8 - 32	.13	.18	.24	.10	C'Sink	72552	.134	.166	8 - 32	.24	#33	1/16
83291	84291	4 - 40	10 - 32	.17	.22	.31	.12	C'Sink	72554	.161	.194	10 - 32	.28	#29	3/32
83292	84292	6 - 32	12 - 28	.21	.22	.39	.12	C'Sink	72556	.187	.220	12 - 28	.28	#21	3/32
83294	84294	8 - 32	1/4 - 28 [†]	.25	.24	.43	.13	C'Sink	72558	.228	.255	1/4 - 28	.30	#8	3/32

* To complete the abbreviated Insert part numbers in the table above use the prefix "218-0". Install Tools use "217-0".

[†] Modified Minor Diameter

¹ Tap Drill Hole Tolerance: .130 to .233 = $+.003/-0.001$

Lightweight - Inch

PART NUMBER*		INSERT							INSTALLATION					REMOVAL	
Non-Lock	Self-Lock	Internal Thread Class 3B	External Thread (Mod.) Class 2A	F Int Thd (min)	G Ext Thd	H Lgth	J $\pm .030$	K C'Bore Depth	Install Tool Part No.*	Tap Drill Size ¹	C'Sink Dia. $+.010$ $-.000$	Thread Tap		Drill	
												Size Class 2B	Min. Depth	Size	Depth
83321	84321	10 - 24	5/16 - 18	.31	.31	.50	.22	.07	72568	.272	.323	5/16 - 18	.37	7/32	5/32
83521	84521	10 - 32													
83322	84322	1/4 - 20	3/8 - 16	.37	.37	.62	.22	.07	72570	.332	.385	3/8 - 16	.43	9/32	3/16
83522	84522	1/4 - 28													
83323	84323	5/16 - 18	7/16 - 14	.43	.43	.75	.22	.07	72572	.397	.447	7/16 - 14	.50	11/32	3/16
83523	84523	5/16 - 24													
83324	84324	3/8 - 16	1/2 - 13	.50	.50	.81	.24	.07	72574	.453	.510	1/2 - 13	.56	13/32	3/16
83524	84524	3/8 - 24													
83325	84325	7/16 - 14	9/16 - 12	.56	.56	.87	.27	.07	72576	.516	.572	9/16 - 12	.62	15/32	3/16
83525	84525	7/16 - 20													
83326	84326	1/2 - 13	5/8 - 11	.62	.62	1.06	.28	.07	72578	.578	.635	5/8 - 11	.68	17/32	3/16
83526	84526	1/2 - 20													

* To complete the abbreviated Insert part numbers in the table above use the prefix "218-0". Install Tools use "217-0".

¹ Tap Drill Hole Tolerance: .234 to .500 = $+.004/-0.001$
Over .500 = $+.005/-0.001$



Specific Use - Blind End Keylocking Threaded Inserts

Material: Inserts - 303 CRES
Keys - 302 CRES

Finish: Passivated

Tolerances: ±.010 inch unless specified otherwise.

Internal Threads: Per SAE AS8879

Dimensions: All dimensions below are in inches

Keys: Inserts with an internal thread size of 5/16 and larger are furnished with 4 locking keys. Smaller sizes have 2 locking keys.

Material Identification Mark: None

Lubrication: Dry Film Lube on Self-Locking Inserts only

Performance: MIL-I-45914A

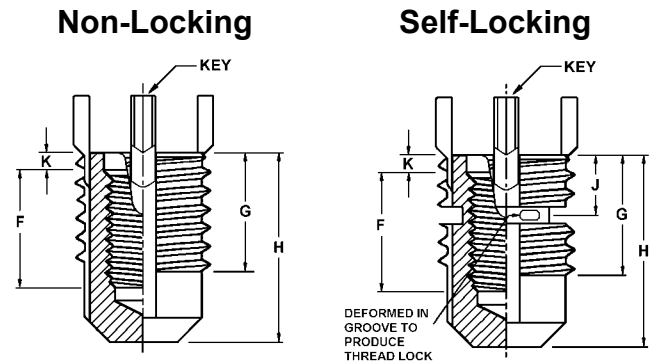

Heavy Duty - Inch

PART NUMBER*		INSERT							INSTALLATION					REMOVAL	
Non-Lock	Self-Lock	Internal Thread Class 3B	External Thread (Mod.) Class 2A	F Int Thd (min)	G Ext Thd	H Lgth	J ±.030	K C'Bore Depth	Install Tool Part No.*	Tap Drill Size ¹	C'Sink Dia. +.010 -.000	Thread Tap		Drill	
												Size Class 2B	Min. Depth	Size	Depth
83300	84300	8 - 32	5/16 - 18	.31	.31	.50	.22	.04	72590	.272	.323	5/16 - 18	.37	7/32	1/8
83301	84301	10 - 24	3/8 - 16	.31	.31	.56	.22	.07	72591	.332	.385	3/8 - 16	.37	9/32	1/8
83501	84501	10 - 32													
83302	84302	1/4 - 20	7/16 - 14	.37	.37	.62	.22	.07	72593	.397	.447	7/16 - 14	.43	11/32	3/16
83502	84502	1/4 - 28													
83303	84303	5/16 - 18	1/2 - 13	.43	.43	.75	.22	.07	72595	.453	.510	1/2 - 13	.50	13/32	3/16
83503	84503	5/16 - 24													
83304	84304	3/8 - 16	9/16 - 12	.50	.50	.81	.25	.07	72597	.516	.572	9/16 - 12	.56	15/32	3/16
83504	84504	3/8 - 24													
83305	84305	7/16 - 14	5/8 - 11	.62	.62	1.00	.28	.10	72599	.578	.635	5/8 - 11	.68	17/32	3/16
83505	84505	7/16 - 20													
83306	84306	1/2 - 13	11/16 - 11 NS	.68	.68	1.06	.28	.10	72601	.641	.700	11/16 - 11 NS	.75	19/32	3/16
83506	84506	1/2 - 20													
83307	84307	9/16 - 12	13/16 - 16	.81	.81	1.25	.32	.10	72603	.766	.822	13/16-16	.94	23/32	3/16
83507	84507	9/16 - 18													
83308	84308	5/8 - 11	7/8-14	.87	.87	1.31	.33	.10	72605	.828	.885	7/8 - 14	1.00	25/32	3/16
83508	84508	5/8 - 18													
83309	84309	3/4 - 10	1-1/8 - 12	1.25	1.25	1.75	.49	.10	72607	1.062	1.145	1-1/8 - 12	1.44	31/32	5/16
83509	84509	3/4 - 16													
83310	84310	7/8 - 9	1-1/4 - 12	1.37	1.37	1.94	.49	.10	72609	1.187	1.270	1-1/4 - 12	1.56	1-3/32	5/16
83510	84510	7/8 - 14													
83311	84311	1" - 8	1-3/8 - 12	1.50	1.50	2.12	.55	.10	72611	1.312	1.395	1-3/8 - 12	1.68	1-7/32	5/16
83511	84511	1" - 12													

* To complete the abbreviated Insert part numbers in the table above use the prefix "218-0". Install Tools use "217-0".

¹ Tap Drill Hole Tolerance: .234 to .500 = +.004/-0.001
Over .500 = +.005/-0.001

Specific Use - Floating Keylocking Threaded Inserts



Material: Inserts - 303 CRES
 Keys and Retaining Ring - 302 CRES
 Finish: Passivated
 Tolerances: ±.010 inch unless specified otherwise
 Internal Threads: Per SAE AS8879
 Dimensions: All dimensions below are in inches
 Keys: Miniature Inserts are furnished with 2 locking keys
 Material Identification Mark: None
 Lubrication: Dry Film Lube on Self-Locking Inserts only

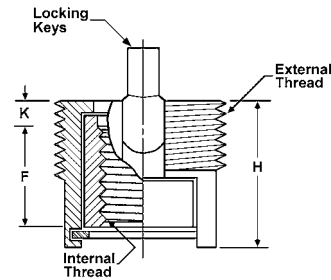

Miniature - Inch

PART NUMBER*		INSERT						INSTALLATION					REMOVAL	
Non-Lock	Self-Lock	Internal Thread Class 3B	External Thread Class 2A	F Internal Thd Lgth	H Lgth ±.015	K Dist. to 1st Thd (Approx)	Min. C - C Float	Install Tool Part No.*	Tap Drill Size ¹	C'Sink Dia. +.010 -0.000	Thread Tap		Drill	
											Size Class 2B	Min. Depth	Size	Depth
87283	87583	2 - 56	1/4 - 28†	.10	.19	.05	.015	82931	.228	.250	1/4 - 28	.12	#8	3/32
87284	87584	4 - 40	5/16 - 24	.21	.32	.07	.020	82932	.272	.323	5/16 - 24	.31	7/32	1/8
87285	87585	6 - 32	3/8 - 24	.22	.36	.08	.030	82933	.332	.385	3/8 - 24	.38	9/32	1/8
87286	87586	8 - 32	3/8 - 24	.22	.36	.08	.030	82934	.332	.385	3/8 - 24	.38	9/32	1/8

* To complete the abbreviated part numbers in the table above use the prefix "218-0"

† Modified Minor Diameter

¹ Tap Drill Hole Tolerance: .130 to .233 = +.003/-0.01
 .234 to .500 = +.004/-0.01

Material: Inserts - 4140 Alloy Steel (160 KSI Min)
 Keys and Retaining Rings - 302 CRES

Finish: Cadmium Plate (QQ-P-416 Type II, Cl. 2)
 Tolerances: ±.010 inch unless specified otherwise.
 Internal Threads: Per SAE AS8879

Dimensions: All dimensions below are in inches
 Keys: Inserts with an internal thread size of 5/16 and larger are furnished with 4 locking keys. Smaller sizes have 2 locking keys.

Material Identification Mark: Two lines on top of Insert
 Lubrication: Dry Film Lube on Self-Locking Inserts only

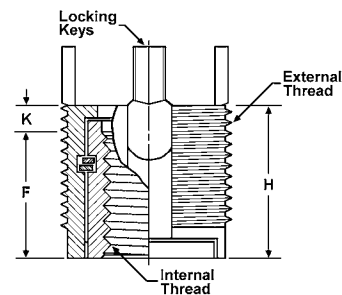

Heavy Duty - Inch

PART NUMBER*		INSERT						INSTALLATION					REMOVAL	
Non-Lock	Self-Lock	Internal Thread Class 3B	External Thread (Mod.) Class 2A	F Internal Thd Lgth	H Lgth ±.015	K Dist. to 1st Thd (Approx)	Min. C - C Float	Install Tool Part No.*	Tap Drill Size ¹	C'Sink Dia. +.010 -0.000	Thread Tap		Drill	
											Size Class 2B	Min. Depth	Size	Depth
89301	89501	10 - 24	7/16 - 20	.25	.40	.15	.040	82941	.406	.447	7/16 - 20	.39	11/32	5/32
89401	89601	10 - 32												
89302	89502	1/4 - 20	1/2 - 20	.25	.40	.15	.040	82942	.468	.510	1/2 - 20	.39	13/32	5/32
89402	89602	1/4 - 28												
89303	89503	5/16 - 18	5/8 - 18	.39	.53	.13	.040	82943	.578	.635	5/8 - 18	.50	17/32	3/16
89403	89603	5/16 - 24												
89304	89504	3/8 - 16	3/4 - 16	.45	.65	.20	.040	82944	.703	.760	3/4 - 16	.62	21/32	3/16
89404	89604	3/8 - 24												
89305	89505	7/16 - 14	7/8 - 14	.45	.67	.20	.040	82945	.828	.885	7/8 - 14	.62	25/32	3/16
89405	89605	7/16 - 20												
89306	89506	1/2 - 13	1" - 12	.50	.73	.23	.040	82946	.937	1.020	1" - 12	.65	27/32	5/16
89406	89606	1/2 - 20												

* To complete the abbreviated part numbers in the table above use the prefix "218-0"

¹ Tap Drill Hole Tolerance: .234 to .500 = +.004/-0.01
 Over .500 = +.005/-0.01



Specific Use - Solid Keylocking Threaded Inserts

Material: Inserts -
 Carbon Steel - C1215 or Equiv.
 Stainless Steel - 303 CRES
 Keys - 302 CRES

Finish: Carbon Steel - Zinc Phosphate
 Stainless Steel - Passivated

Tolerances: ± 0.010 inch or ± 0.25 mm unless specified otherwise.

Dimensions: Are in inches except metric inserts are in millimeters

Keys: Inserts with an external thread size of 7/16 or M 12 and larger have 4 locking keys. Smaller sizes have 2 locking keys.

Material Identification Mark: None

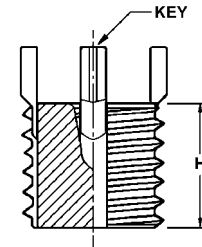

Solid - Inch

PART NUMBER*		INSERT		INSTALLATION					REMOVAL	
Carbon Steel	Stainless Steel	External Thread (Mod.) Class 2A	Length	Installation Tool Part No.*	Tap Drill Size ¹	C'Sink Dia. $+0.010$ -0.000	Thread Tap		Drill	
							Size Class 2B	Min. Depth	Size	Depth
66001	66401	5/16 - 18	.31	64801	.272	.32	5/16 - 18	.37	7/32	1/8
66002	66402	3/8 - 16	.31	64802	.332	.38	3/8 - 16	.37	9/32	1/8
66003	66403	7/16 - 14	.37	64803	.397	.44	7/16 - 14	.43	11/32	3/16
66004	66404	1/2 - 13	.43	64804	.453	.51	1/2 - 13	.50	13/32	3/16
66005	66405	9/16 - 12	.50	64805	.516	.57	9/16 - 12	.56	15/32	3/16
66006	66406	5/8 - 11	.62	64806	.578	.63	5/8 - 11	.68	17/32	3/16
—	66413	11/16 - 11 NS	.68	64813	.641	.70	11/16 - 11 NS	.75	19/32	3/16
66007	66407	3/4 - 16	.68	64807	.703	.76	3/4 - 16	.75	21/32	3/16
—	66414	13/16 - 16	.81	64814	.766	.82	13/16 - 16	.94	23/32	3/16
66008	66408	7/8 - 14	.87	64808	.828	.88	7/8 - 14	1.00	25/32	5/16
66009	66409	1" - 12	.87	64809	.937	1.02	1" - 12	1.00	27/32	5/16
66010	66410	1-1/8 - 12	1.12	64810	1.062	1.14	1-1/8 - 12	1.31	31/32	5/16
66011	66411	1-1/4 - 12	1.25	64811	1.187	1.27	1-1/4 - 12	1.44	1-3/32	5/16
66012	66412	1-3/8 - 12	1.37	64812	1.312	1.39	1-3/8 - 12	1.56	1-7/32	5/16

* To complete the abbreviated part numbers in the table above use the prefix "215-0"

¹ Tap Drill Hole Tolerance: .234 to .500 = $+0.004/-0.001$
 Over .500 = $+0.005/-0.001$

Solid - Metric

PART NUMBER*		INSERT		INSTALLATION					REMOVAL	
Carbon Steel	Stainless Steel	External Thread Class 6g	Length	Installation Tool Part No.*	Tap Drill Size ¹	C'Sink Dia. $+0.25$ -0.00	Thread Tap		Drill	
							Size Class 6H	Min. Depth	Size	Depth
66021	66421	M 8x1.25	8.0	64821	6.90	8.25	M 8x1.25	9.5	5.50	4.00
66022	66422	M 10x1.25	10.0	64822	8.80	10.25	M 10x1.25	12.5	7.50	4.75
66023	66423	M 12x1.25	12.0	64823	10.80	12.25	M 12x1.25	14.5	9.50	4.75
66024	66424	M 14x1.5	14.0	64824	12.80	14.25	M 14x1.5	16.5	11.50	4.75
66025	66425	M 16x1.5	16.0	64825	14.75	16.25	M 16x1.5	18.5	13.50	4.75
66026	66426	M 18x1.5	18.0	64826	16.75	18.25	M 18x1.5	20.5	15.50	4.75
66027	66427	M 20x1.5	20.0	64827	18.75	20.25	M 20x1.5	22.5	17.50	4.75
66028	66428	M 22x1.5	22.0	64828	20.50	22.25	M 22x1.5	24.5	17.75	6.35
66029	66429	M 24x1.5	24.0	64829	22.50	24.25	M 24x1.5	26.5	19.75	6.35
66030	66430	M 30x2.0	30.0	64830	28.00	30.25	M 30x2.0	34.5	25.75	6.35
66031	66431	M 32x2.0	32.0	64831	30.00	32.25	M 32x2.0	36.5	27.75	6.35
66032	66432	M 33x2.0	33.0	64832	31.00	33.25	M 33x2.0	37.5	28.75	6.35

* To complete the abbreviated part numbers in the table above use the prefix "215-0"

¹ Tap Drill Hole Tolerance: 6.90 to 10.80 = $+0.100/-0.025$
 Over 12.80 = $+0.130/-0.025$

Specific Use - Cast-In Threaded Inserts



Material: Stainless - 303 or equivalent
Brass - 360 or equivalent

Finish: Stainless steel - Passivated
Brass - None

Dimensions: Are in inches except metric inserts are in millimeters

Tolerances: $\pm .005$ inch or $\pm .13$ mm unless specified otherwise.

Material Identification Mark: None

Lubrication: None

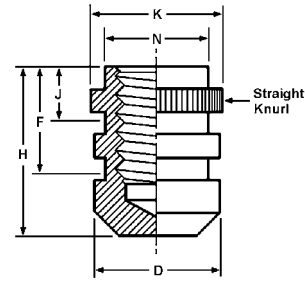

Cast-In Inserts - Inch

PART NUMBER*			DIMENSIONS						
Stainless	Stainless Self-Locking	Brass	Internal Thread Class 2B	D Major Outside Dia.	F Min. Full Thread	H Overall Length	J Dist. to Lock (Ref)	K Over Knurl	N Minor Outside Dia.
80002	80102	80202	4 - 40	3/16	.16	.31	3/32	.200	.160
80003	80103	80203	6 - 32	1/4	.19	.34	3/32	.262	.200
80004	80104	80204	8 - 32	9/32	.22	.37	1/8	.294	.230
80005	80105	80205	10 - 24	5/16	.28	.43	5/32	.324	.265
80006	80106	80206	10 - 32						
80007	80107	80207	1/4 - 20	3/8	.37	.62	3/16	.386	.345
80008	80108	80208	1/4 - 28						
80009	80109	80209	5/16 - 18	7/16	.43	.68	3/16	.451	.407
80010	80110	80210	5/16 - 24						
80011	80111	80211	3/8 - 16	9/16	.50	.75	3/16	.576	.522
80012	80112	80212	3/8 - 24						

* To complete the abbreviated part number in the table above use the prefix "216-0"

Cast-In Inserts - Metric

PART NUMBER*			DIMENSIONS						
Stainless	Stainless Self-Locking	Brass	Internal Thread Class 6H	D Major Outside Dia.	F Min. Full Thread	H Overall Length	J Dist. to Lock (Ref)	K Over Knurl	N Minor Outside Dia.
80031	80131	80231	M 3 X 0.5	5.0	4.5	8.5	2.4	5.4	4.3
80032	80132	80232	M 3.5 X 0.6	6.5	5.0	9.0	2.4	6.9	5.2
80033	80133	80233	M 4 X 0.7	7.0	5.5	9.5	3.9	7.4	5.7
80034	80134	80234	M 5 X 0.8	8.0	7.5	11.5	3.9	8.4	6.8
80035	80135	80235	M 6 X 1.0	9.5	9.5	15.5	3.9	9.9	8.7
80036	80136	80236	M 8 X 1.25	11.5	11.5	18.0	4.8	11.9	10.7
80037	80137	80237	M 8 X 1.0						
80038	80138	80238	M 10 X 1.5	15.0	13.5	20.0	4.8	15.4	13.9
80039	80139	80239	M 10 X 1.25						

* To complete the abbreviated part number in the table above use the prefix "216-0"



Industrial Style - Bulk Packed Keylocking Threaded Inserts

Thinwall - Inch

PART NUMBER*		INSERT			INSTALLATION					REMOVAL	
Carbon Steel	Stainless Steel	Internal Thread Class 2B	External Thread (Mod.) Class 2A	Length	Installation Tool Part No.*	Tap Drill Size	C'Sink Dia. $^{+.010}_{-.000}$	Thread Tap		Drill	
								Size Class 2B	Min. Depth	Size	Depth
65921	66321	10 - 24	5/16 - 18	.31	64721	"I"	.32	5/16 - 18	.37	7/32	1/8
66121	66521	10 - 32									
65922	66322	1/4 - 20	3/8 - 16	.37	64722	"Q"	.38	3/8 - 16	.43	9/32	3/16
66122	66522	1/4 - 28									
65923	66323	5/16 - 18	7/16 - 14	.43	64723	"X"	.44	7/16 - 14	.50	11/32	3/16
66123	66523	5/16 - 24									
65924	66324	3/8 - 16	1/2 - 13	.50	64724	29/64	.51	1/2 - 13	.56	13/32	3/16
66124	66524	3/8 - 24									
65925	66325	7/16 - 14	9/16 - 12	.56	64725	33/64	.57	9/16 - 12	.62	15/32	3/16
66125	66525	7/16 - 20									
65926	66326	1/2 - 13	5/8 - 11	.62	64726	37/64	.63	5/8 - 11	.68	17/32	3/16
66126	66526	1/2 - 20									

* To complete the abbreviated part numbers in the table above use the prefix "215-0"

Heavy Duty - Inch

PART NUMBER*		INSERT			INSTALLATION					REMOVAL	
Carbon Steel	Stainless Steel	Internal Thread Class 2B	External Thread (Mod.) Class 2A	Length	Installation Tool Part No.*	Tap Drill Size	C'Sink Dia. $^{+.010}_{-.000}$	Thread Tap		Drill	
								Size Class 2B	Min. Depth	Size	Depth
65900	66300	8 - 32	5/16 - 18	.31	64700	"I"	.32	5/16 - 18	.37	7/32	1/8
65901	66301	10 - 24	3/8 - 16	.31	64701	"Q"	.38	3/8 - 16	.37	9/32	1/8
66101	66501	10 - 32									
65902	66302	1/4 - 20	7/16 - 14	.37	64702	"X"	.44	7/16 - 14	.43	11/32	3/16
66102	66502	1/4 - 28									
65903	66303	5/16 - 18	1/2 - 13	.43	64703	29/64	.51	1/2 - 13	.50	13/32	3/16
66103	66503	5/16 - 24									
65904	66304	3/8 - 16	9/16 - 12	.50	64704	33/64	.57	9/16 - 12	.56	15/32	3/16
66104	66504	3/8 - 24									
65905	66305	7/16 - 14	5/8 - 11	.62	64705	37/64	.63	5/8 - 11	.68	17/32	3/16
66105	66505	7/16 - 20									
65906	66306	1/2 - 13	3/4 - 16	.62	64706	45/64	.76	3/4 - 16	.68	21/32	3/16
66106	66506	1/2 - 20									
65907	66307	9/16 - 12	3/4 - 16	.81	64707	45/64	.76	3/4 - 16	.94	21/32	3/16
66107	66507	9/16 - 18									
65908	66308	5/8 - 11	7/8 - 14	.87	64708	53/64	.88	7/8 - 14	1.00	25/32	5/16
66108	66508	5/8 - 18									
65909	66309	3/4 - 10	1-1/8 - 12	1.12	64709	1-1/16	1.14	1-1/8 - 12	1.31	31/32	5/16
66109	66509	3/4 - 16									
65910	66310	7/8 - 9	1-1/4 - 12	1.25	64710	1-3/16	1.27	1-1/4 - 12	1.44	1-3/32	5/16
66110	66510	7/8 - 14									
65911	66311	1" - 8	1-3/8 - 12	1.37	64711	1-5/16	1.39	1-3/8 - 12	1.56	1-7/32	5/16
66111	66511	1" - 12									
66112	—	1" - 14									
65913	—	1-1/8 - 7	1-1/2 - 12	1.62	64713	1-7/16	1.52	1-1/2 - 12	1.84	1-11/32	5/16
66113	—	1-1/8 - 12									
65914	—	1-1/4 - 7	1-5/8 - 12	1.81	64714	1-9/16	1.64	1-5/8 - 12	2.06	1-15/32	5/16
66114	—	1-1/4 - 12									
65916	—	1-1/2 - 6	1-7/8 - 12	2.00	64716	1-13/16	1.89	1-7/8 - 12	2.28	1-23/32	5/16
66116	—	1-1/2 - 12									

* To complete the abbreviated part numbers in the table above use the prefix "215-0"

Industrial Style - Bulk Packed Keylocking Threaded Inserts



Extra Heavy Duty - Inch

PART NUMBER*		INSERT			INSTALLATION					REMOVAL	
Carbon Steel	Stainless Steel	Internal Thread Class 2B	External Thread (Mod.) Class 2A	Length	Installation Tool Part No.*	Tap Drill Size	C'Sink Dia. $^{+.010}_{-.000}$	Thread Tap		Drill	
								Size Class 2B	Min. Depth	Size	Depth
65931	66331	6 - 32	5/16 - 18	.31	64731	"I"	.32	5/16 - 18	.37	7/32	1/8
65932	66332	8 - 32	3/8 - 16	.31	64732	"Q"	.38	3/8 - 16	.37	9/32	1/8
65933	66333	10 - 24	7/16 - 14	.31	64733	"X"	.44	7/16 - 14	.37	11/32	3/16
66133	66533	10 - 32									
65934	66334	1/4 - 20	1/2 - 13	.37	64734	29/64	.51	1/2 - 13	.43	13/32	3/16
66134	66534	1/4 - 28									
65935	66335	5/16 - 18	9/16 - 12	.43	64735	33/64	.57	9/16 - 12	.50	15/32	3/16
66135	66535	5/16 - 24									
65936	66336	3/8 - 16	5/8 - 11	.50	64736	37/64	.63	5/8 - 11	.56	17/32	3/16
66136	66536	3/8 - 24									
65937	66337	7/16 - 14	3/4 - 16	.62	64737	45/64	.76	3/4 - 16	.68	21/32	3/16
66137	66537	7/16 - 20									
65938	66338	1/2 - 13	7/8 - 14	.68	64738	53/64	.88	7/8 - 14	.75	25/32	5/16
66138	66538	1/2 - 20									
65939	66339	9/16 - 12	7/8 - 14	.81	64739	53/64	.88	7/8 - 14	.94	25/32	5/16
66139	66539	9/16 - 18									
65940	66340	5/8 - 11	1" - 12	.87	64740	15/16	1.02	1" - 12	1.00	27/32	5/16
66140	66540	5/8 - 18									
65941	66341	3/4 - 10	1-1/4 - 12	1.12	64741	1-3/16	1.27	1-1/4 - 12	1.31	1-3/32	5/16
66141	66541	3/4 - 16									
65942	66342	7/8 - 9	1-3/8 - 12	1.25	64742	1-5/16	1.39	1-3/8 - 12	1.44	1-7/32	5/16
66142	66542	7/8 - 14									
65943	66343	1" - 8	1-1/2 - 12	1.37	64743	1-7/16	1.52	1-1/2 - 12	1.56	1-11/32	5/16
66143	66543	1" - 12									

* To complete the abbreviated part numbers in the table above use the prefix "215-0"

General Information For Industrial Style Keylocking Threaded Inserts

Material: Inserts -
 Carbon Steel - C1215 or equivalent
 Stainless Steel - 303 or equivalent
 Keys - 302 CRES or equivalent

Finish: Carbon Steel - Zinc Phosphate
 Stainless Steel - Passivated

Tolerances: $\pm .010$ inch or $\pm .25$ mm unless specified otherwise.

Dimensions: Are in inches except metric inserts are in millimeters.
 Metric/Inch inserts have a metric internal thread while all other dimensions are in inches.

Keys: Inserts with an internal thread size of 5/16 or M7 and larger have 4 locking keys. Smaller sizes have 2 locking keys.

Tap Drill Hole Tolerance: Inch - .234 to .500 = $+.004/- .001$
 Over .500 = $+.005/- .001$
 Metric - 6.90 to 10.80 = $+.100/- .025$
 Over 12.80 = $+.130/- .025$

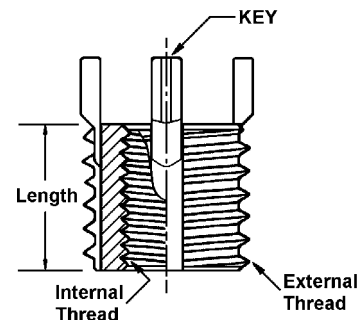

See Page 2 for Installation and Removal Instructions



Industrial Style - Bulk Packed Keylocking Threaded Inserts

Thinwall - Metric

PART NUMBER*		INSERT			INSTALLATION				REMOVAL		
Carbon Steel	Stainless Steel	Internal Thread Class 6H	External Thread Class 6g	Length	Installation Tool Part No.*	Tap Drill Size	C'Sink Dia. +.25 -.00	Thread Tap		Drill	
								Size Class 6H	Min. Depth	Size	Depth
65951	66351	M 5x0.8	M 8x1.25	8.0	64751	6.9	8.25	M 8x1.25	9.5	5.50	4.00
65952	66352	M 6x1.0	M 10x1.25	10.0	64752	8.8	10.25	M 10x1.25	11.5	7.50	4.75
65953	66353	M 8x1.25	M 12x1.25	12.0	64753	10.8	12.25	M 12x1.25	13.5	9.50	4.75
66153	66553	M 8x1.0									
65955	66355	M 10x1.5	M 14x1.5	14.0	64755	12.8	14.25	M 14x1.5	15.5	11.50	4.75
66155	66555	M 10x1.25									
65956	66356	M 12x1.75	M 16x1.5	16.0	64756	14.75	16.25	M 16x1.5	17.5	13.50	4.75
66156	66556	M 12x1.25									

* To complete the abbreviated part numbers in the table above use the prefix "215-0"

Heavy Duty - Metric

PART NUMBER*		INSERT			INSTALLATION				REMOVAL		
Carbon Steel	Stainless Steel	Internal Thread Class 6H	External Thread Class 6g	Length	Installation Tool Part No.*	Tap Drill Size	C'Sink Dia. +.25 -.00	Thread Tap		Drill	
								Size Class 6H	Min. Depth	Size	Depth
65963	66363	M 4x0.7	M 8x1.25	8.0	64763	6.9	8.25	M 8x1.25	9.5	5.50	4.00
65964	66364	M 5x0.8	M 10x1.25	10.0	64764	8.8	10.25	M 10x1.25	12.5	7.50	4.75
65965	66365	M 6x1.0	M 12x1.25	12.0	64765	10.8	12.25	M 12x1.25	14.5	9.50	4.75
65966	66366	M 8x1.25	M 14x1.5	14.0	64766	12.8	14.25	M 14x1.5	16.5	11.50	4.75
66166	66566	M 8x1.0									
65967	66367	M 10x1.5	M 16x1.5	16.0	64767	14.75	16.25	M 16x1.5	18.5	13.50	4.75
66167	66567	M 10x1.25									
65969	66369	M 12x1.75	M 18x1.5	18.0	64769	16.75	18.25	M 18x1.5	20.5	15.50	4.75
66169	66569	M 12x1.25									
65970	66370	M 14x2.0	M 20x1.5	20.0	64770	18.75	20.25	M 20x1.5	22.5	17.50	4.75
66170	66570	M 14x1.5									
65971	66371	M 16x2.0	M 22x1.5	22.0	64771	20.5	22.25	M 22x1.5	24.5	17.75	6.35
66171	66571	M 16x1.5									
66172	66572	M 18x1.5	M 24x1.5	24.0	64772	22.5	24.25	M 24x1.5	26.5	19.75	6.35
65973	66373	M 20x2.5	M 30x2.0	30.0	64773	28.0	30.25	M 30x2.0	34.5	25.75	6.35
66173	66573	M 20x1.5									
66174	66574	M 22x1.5	M 32x2.0	32.0	64774	30.0	32.25	M 32x2.0	36.5	27.75	6.35
65975	66375	M 24x3.0	M 33x2.0	33.0	64775	31.0	33.25	M 33x2.0	37.5	28.75	6.35
66175	66575	M 24x2.0									

* To complete the abbreviated part numbers in the table above use the prefix "215-0"

Metric Internal / Inch External

PART NUMBER*		INSERT			INSTALLATION				REMOVAL		
Carbon Steel	Stainless Steel	Internal Thread Class 6H	External Thread (Mod.) Class 2A	Length	Installation Tool Part No.	Tap Drill Size	C'Sink Dia. +.010 -.000	Thread Tap		Drill	
								Size Class 2B	Min. Depth	Size	Depth
66243	66643	M 6x1.0	3/8 - 16	.31	64843	"Q"	.38	3/8 - 16	.37	9/32	1/8
66244	66644	M 8x1.25	1/2 - 13	.43	64844	29/64	.51	1/2 - 13	.50	13/32	3/16
66245	66645	M 10x1.5	5/8 - 11	.50	64845	37/64	.63	5/8 - 11	.56	17/32	3/16
66247	66647	M 12x1.75	3/4 - 16	.62	64847	45/64	.76	3/4 - 16	.68	21/32	3/16
66248	66648	M 14x2.0	7/8 - 14	.81	64848	53/64	.88	7/8 - 14	.94	25/32	5/16
66249	66649	M 16x2.0	1" - 12	.87	64849	15/16	1.02	1" - 12	1.00	27/32	5/16

* To complete the abbreviated part numbers in the table above use the prefix "215-0"
(All dimensions are specified in inches except internal thread is metric.)

Industrial Style - Single Size Kits Keylocking Threaded Inserts



Thinwall - Inch

PART NUMBER*		Internal Thread Class 2B	External Thread (Mod.) Class 2A	Length	Number of Inserts Per Kit
Carbon Steel	Stainless Steel				
67921	68321	10 - 24	5/16-18	.31	9
68121	68521	10 - 32			
67922	68322	1/4 - 20	3/8 - 16	.37	8
68122	68522	1/4 - 28			
67923	68323	5/16 - 18	7/16 - 14	.43	7
68123	68523	5/16 - 24			
67924	68324	3/8 - 16	1/2 - 13	.50	6
68124	68524	3/8 - 24			
67925	68325	7/16 - 14	9/16 - 12	.56	6
68125	68525	7/16 - 20			
67926	68326	1/2 - 13	5/8 - 11	.62	4
68126	68526	1/2 - 20			

* To complete the abbreviated part numbers in the table above use the prefix "215-0"

Heavy Duty - Inch

PART NUMBER*		Internal Thread Class 2B	External Thread (Mod.) Class 2A	Length	Number of Inserts Per Kit
Carbon Steel	Stainless Steel				
67900	68300	8 - 32	5/16 - 18	.31	9
67901	68301	10 - 24	3/8 - 16	.31	9
68101	68501	10 - 32			
67902	68302	1/4 - 20	7/16 - 14	.37	8
68102	68502	1/4 - 28			
67903	68303	5/16 - 18	1/2 - 13	.43	7
68103	68503	5/16 - 24			
67904	68304	3/8 - 16	9/16 - 12	.50	6
68104	68504	3/8 - 24			
67905	68305	7/16 - 14	5/8 - 11	.62	6
68105	68505	7/16 - 20			
67906	68306	1/2 - 13	3/4 - 16	.62	4
68106	68506	1/2 - 20			
67907	68307	9/16 - 12	3/4 - 16	.81	3
68107	68507	9/16 - 18			
67908	68308	5/8 - 11	7/8 - 14	.87	3
68108	68508	5/8 - 18			
67909	68309	3/4 - 10	1-1/8 - 12	1.12	3
68109	68509	3/4 - 16			
67910	68310	7/8 - 9	1-1/4 - 12	1.25	3
68110	68510	7/8 - 14			
67911	68311	1" - 8	1-3/8 - 12	1.37	2
68111	68511	1" - 12			
67913	—	1-1/8 - 7	1-1/2 - 12	1.62	2
68113	—	1-1/8 - 12			
67914	—	1-1/4 - 7	1-5/8 - 12	1.81	2
68114	—	1-1/4 - 12			
67916	—	1-1/2 - 6	1-7/8 - 12	2.00	2
68116	—	1-1/2 - 12			

* To complete the abbreviated part numbers in the table above use the prefix "215-0"



Single Size Kits contain inserts of one size per box. Each Single Size Kit includes the quantity of inserts shown in the chart, one installation tool, and instructions for installation and removal.



Industrial Style - Single Size Kits Keylocking Threaded Inserts

Thinwall - Metric

PART NUMBER*		Internal Thread Class 6H	External Thread Class 6g	Length	Number of Inserts Per Kit
Carbon Steel	Stainless Steel				
67951	68351	M 5x0.8	M 8x1.25	8.0	8
67952	68352	M 6x1.0	M 10x1.25	10.0	8
67953	68353	M 8x1.25	M 12x1.25	12.0	6
68153	68553	M 8x1.0			
67955	68355	M 10x1.5	M 14x1.5	14.0	4
68155	68555	M 10x1.25			
67956	68356	M 12x1.75	M 16x1.5	16.0	3
68156	68556	M 12x1.25			

* To complete the abbreviated part numbers in the table above use the prefix "215-0"

Heavy Duty - Metric

PART NUMBER*		Internal Thread Class 6H	External Thread Class 6g	Length	Number of Inserts Per Kit
Carbon Steel	Stainless Steel				
67963	68363	M 4x0.7	M 8x1.25	8.0	9
67964	68364	M 5x0.8	M 10x1.25	10.0	8
67965	68365	M 6x1.0	M 12x1.25	12.0	8
67966	68366	M 8x1.25	M 14x1.5	14.0	6
68166	68566	M 8x1.0			
67967	68367	M 10x1.5	M 16x1.5	16.0	4
68167	68567	M 10x1.25			
67969	68369	M 12x1.75	M 18x1.5	18.0	3
68169	68569	M 12x1.25			
67970	68370	M 14x2.0	M 20x1.5	20.0	4
68170	68570	M 14x1.5			
67971	68371	M 16x2.0	M 22x1.5	22.0	3
68171	68571	M 16x1.5			
68172	68572	M 18x1.5	M 24x1.5	24.0	2
67973	68373	M 20x2.5	M 30x2.0	30.0	3
68173	68573	M 20x1.5			
68174	68574	M 22x1.5	M 32x2.0	32.0	3
67975	68375	M 24x3.0	M 33x2.0	33.0	2
68175	68575	M 24x2.0			

* To complete the abbreviated part numbers in the table above use the prefix "215-0"

Metric Internal / Inch External

PART NUMBER*		Internal Thread Class 6H	External Thread (Mod.) Class 2A	Length	Number of Inserts Per Kit
Carbon Steel	Stainless Steel				
68243	68643	M 6x1.0	3/8 - 16	.31	8
68244	68644	M 8x1.25	1/2 - 13	.43	8
68245	68645	M 10x1.5	5/8 - 11	.50	6
68247	68647	M 12x1.75	3/4 - 16	.62	4
68248	68648	M 14x2.0	7/8 - 14	.81	3
68249	68649	M 16x2.0	1" - 12	.87	3

* To complete the abbreviated part numbers in the table above use the prefix "215-0"

Industrial Style - Assortment Kits

Keylocking Threaded Inserts



Large Assortments

Thinwall - Inch Coarse Series

Internal Thread Class 2B	External Thread (Mod.) Class 2A	Length	Quantity of Inserts per Kit
10 - 24	5/16 - 18	.31	20
1/4 - 20	3/8 - 16	.37	20
5/16 - 18	7/16 - 14	.43	15
3/8 - 16	1/2 - 13	.50	10
7/16 - 14	9/16 - 12	.56	10
1/2 - 13	5/8 - 11	.62	6

Carbon Steel Kit Part Number: **215-064943**
 Stainless Steel Kit Part Number: **215-064963**

Thinwall - Inch Fine Series

Internal Thread Class 2B	External Thread (Mod.) Class 2A	Length	Quantity of Inserts per Kit
10 - 32	5/16 - 18	.31	20
1/4 - 28	3/8 - 16	.37	20
5/16 - 24	7/16 - 14	.43	15
3/8 - 24	1/2 - 13	.50	10
7/16 - 20	9/16 - 12	.56	10
1/2 - 20	5/8 - 11	.62	6

Carbon Steel Kit Part Number: **215-064944**
 Stainless Steel Kit Part Number: **215-064964**

Heavy Duty - Inch Coarse Series

Internal Thread Class 2B	External Thread (Mod.) Class 2A	Length	Quantity of Inserts per Kit
1/4 - 20	7/16 - 14	.37	20
5/16 - 18	1/2 - 13	.43	15
3/8 - 16	9/16 - 12	.50	10
7/16 - 14	5/8 - 11	.62	10
1/2 - 13	3/4 - 16	.62	6
9/16 - 12	3/4 - 16	.81	5
5/8 - 11	7/8 - 14	.87	3
3/4 - 10	1-1/8 - 12	1.12	3
7/8 - 9	1-1/4 - 12	1.25	3
1" - 8	1-3/8 - 12	1.37	2

Carbon Steel Kit Part Number: **215-064941**
 Stainless Steel Kit Part Number: **215-064966**

Heavy Duty - Inch Fine Series

Internal Thread Class 2B	External Thread (Mod.) Class 2A	Length	Quantity of Inserts per Kit
1/4 - 28	7/16 - 14	.37	20
5/16 - 24	1/2 - 13	.43	15
3/8 - 24	9/16 - 12	.50	10
7/16 - 20	5/8 - 11	.62	10
1/2 - 20	3/4 - 16	.62	6
9/16 - 18	3/4 - 16	.81	5
5/8 - 18	7/8 - 14	.87	3
3/4 - 16	1-1/8 - 12	1.12	3
7/8 - 14	1-1/4 - 12	1.25	3
1" - 12	1-3/8 - 12	1.37	2

Carbon Steel Kit Part Number: **215-064942**
 Stainless Steel Kit Part Number: **215-064967**

Thinwall - Metric Series

Internal Thread Class 6H	External Thread Class 6g	Length	Quantity of Inserts per Kit
M 6x1.0	M 10x1.25	10.0	20
M 8x1.25	M 12x1.25	12.0	15
M 8x1.0			15
M 10x1.5	M 14x1.5	14.0	10
M 10x1.25			10
M 12x1.75	M 16x1.5	16.0	6
M 12x1.25			6

Carbon Steel Kit Part Number: **215-064945**
 Stainless Steel Kit Part Number: **215-064965**



Industrial Style - Assortment Kits Keylocking Threaded Inserts

Small Assortments

Heavy Duty - Inch Coarse Series

Internal Thread Class 2B	External Thread (Mod.) Class 2A	Length	Quantity of Inserts per Kit
10 - 24	3/8 - 16	.31	5
1/4 - 20	7/16 - 14	.37	10
5/16 - 18	1/2 - 13	.43	10
3/8 - 16	9/16 - 12	.50	10
1/2 - 13	3/4 - 16	.62	10
5/8 - 11	7/8 - 14	.87	10
3/4 - 10	1-1/8 - 12	1.12	5

Carbon Steel Kit Part Number: **215-064951**
Stainless Steel Kit Part Number: **215-064961**

Heavy Duty - Inch Fine Series

Internal Thread Class 2B	External Thread (Mod.) Class 2A	Length	Quantity of Inserts per Kit
10 - 32	3/8 - 16	.31	5
1/4 - 28	7/16 - 14	.37	10
5/16 - 24	1/2 - 13	.43	10
3/8 - 24	9/16 - 12	.50	10
1/2 - 20	3/4 - 16	.62	10
5/8 - 18	7/8 - 14	.87	10
3/4 - 16	1-1/8 - 12	1.12	5

Carbon Steel Kit Part Number: **215-064952**
Stainless Steel Kit Part Number: **215-064962**

Thinwall - Metric Series

Internal Thread Class 6H	External Thread Class 6g	Length	Quantity of Inserts per Kit
M 5x0.8	M 8x1.25	8.0	8
M 6x1.0	M 10x1.25	10.0	8
M 8x1.25	M 12x1.25	12.0	6
M 8x1.0			6
M 10x1.5	M 14x1.5	14.0	4
M 10x1.25			4
M 12x1.75	M 16x1.5	16.0	3
M 12x1.25			3

Carbon Steel Kit Part Number: **215-064983**
Stainless Steel Kit Part Number: **215-064993**



Each Assortment Kit contains a selection of various size inserts and the proper installation tools. Instructions for installation and removal are also included. Assortment Kits provide convenient storage and easy access to the various inserts and tools.

Keylocking Studs

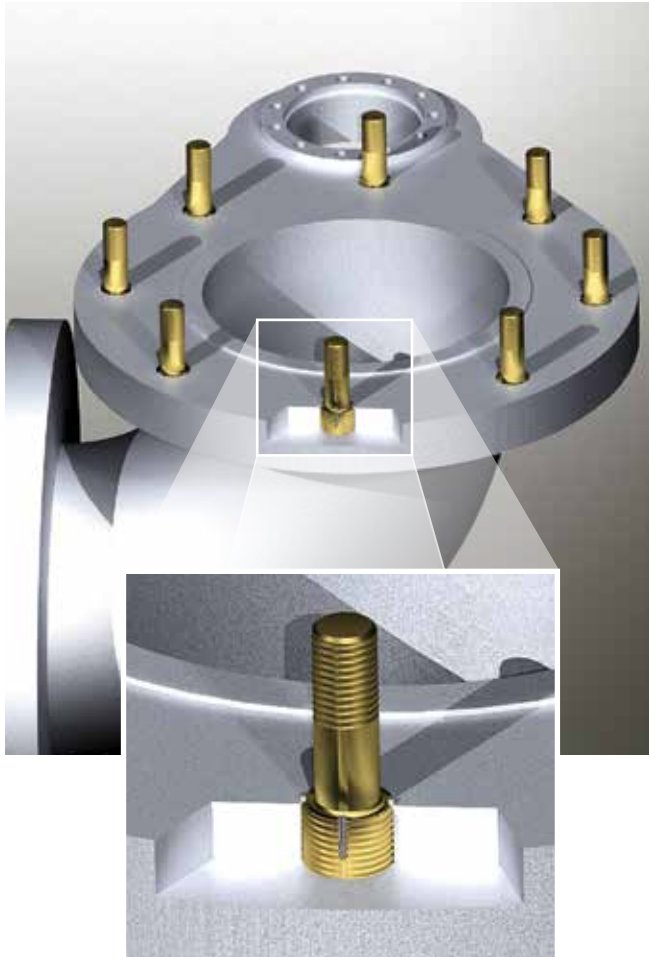

- **Securely Locked with Keys**
- **Solid One-Piece Design Provides High Pull-Out Strength and Torque-Out Capabilities**
- **Ideal for OEM Use and High Vibration Applications**

Acme Keylocking Studs provide security and “repairability” in applications where you can’t use a through-bolt/nut combination. They are superior for use in soft materials such as aluminum or magnesium when extra strength, extended thread life and vibration-resistance are required.

Typical Applications Include:

Aerospace, electronics, automotive, industrial and military. Found on engines, transmissions, housings.



For complete part number conversions, please visit our website at www.acmeindustrial.com.



Easy Installation With Standard Drills and Taps

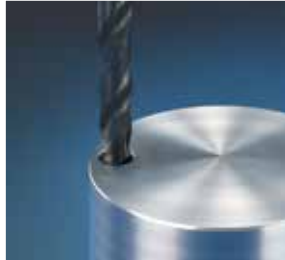

1) Drill with a standard tap drill and countersink with a standard 82° - 100° countersink.



2) Tap new threads with a standard tap.



3) Screw in the stud end until it is .010-.030 below the surface. Keys locate the proper depth.



4) Drive keys down with several hammer taps on the proper installation tool.

- Produced to NAS and SAE standards (MS51833 & MS51834). Produced to AS3543 and AS3544 if requested
- Full range of inch and metric sizes
- Available in 303, A286, and 17-4PH CRES and 4140 Alloy Steel
- Lightweight and heavy duty versions available
- Precision rolled UNJ threads allow transfer of high axial loads into base material

Removable!

If necessary, Acme Keylocking studs can be removed without damage to the parent material:

1. Cut the stud to be flush with parent material.
2. Drill out material between keys with a standard drill (drill bushing required) to specified depth.
3. Bend the keys inward and break off.
4. Remove the old stud using a screw extractor or similar device.
5. Install a replacement stud into the original tapped hole and drive keys down.



Short Lead Times, Competitive Prices, Top Quality, Made in USA

Rely on Acme's manufacturing expertise to provide the performance you expect from a supplier as evidenced by approvals from major worldwide aerospace manufacturers.

Since 1914, Acme Industrial has been a major force in supplying precision steel products to the manufacturing and military sectors. Now, Acme introduces its new **Acme Keylocking Stud** product line to the marketplace. These high-performing studs are engineered and manufactured to meet or exceed today's high quality requirements and demands.

Keylocking Studs MS51834/MS51833

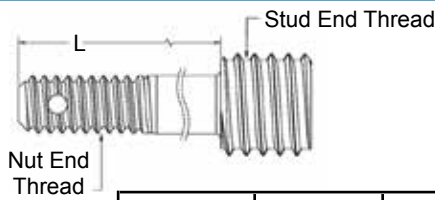

220-0XX XXX - XX

Material
 096 - 303 Stainless Steel
 097 - A286 Stainless Steel
 098 - 4140 Steel

"D" - Crosshole
 Dash -
 No crosshole

Example

220-096300-10

303 Steel
 8-32 Nut End
 No Cross hole
 L = .625

Length
See Chart

Keylocking Stud PART NUMBER	NUT END THREAD CLASS 3A	STUD END THREAD CLASS 2A	INSTALL TOOL PART NUMBER	TAP DRILL TOOL	CSINK DIA
220-0XX300	8-32	5/16-18	220-072890	.272	.323
220-0XX500	8-36				
220-0XX301	10-24	3/8-16	220-072891	.332	.385
220-0XX501	10-32				
220-0XX302	1/4-20	7/16-14	220-072893	.397	.447
220-0XX502	1/4-28				
220-0XX303	5/16-18	1/2-13	220-072895	.453	.510
220-0XX503	5/16-24				
220-0XX304	3/8-16	9/16-12	220-072897	.516	.572
220-0XX504	3/8-25				
220-0XX305	7/16-14	5/8-11	220-072899	.578	.635
220-0XX505	7/16-20				
220-0XX306	1/2-13	11/16-11	220-072901	.641	.700
220-0XX506	1/2-20				
220-0XX307	9/16-12	13/16-16	220-072903	.766	.822
220-0XX507	9/16-18				
220-0XX308	5/8-11	7/8-14	220-072905	.868	.885
220-0XX508	5/8-18				
220-0XX309	3/4-10	1 1/8-12	220-072907	1.062	1.145
220-0XX509	3/4-16				
220-0XX310	7/8-9	1 1/4-12	220-072909	1.187	1.270
220-0XX510	7/8-14				
220-0XX311	1"-8	1 3/8-12	220-072911	1.312	1.395
220-0XX511	1"-12				
220-0XX321	10-24	5/16-18	220-072868	.272	.323
220-0XX521	10-32				
220-0XX322	1/4-20	3/8-16	220-072870	.332	.385
220-0XX522	1/4-28				
220-0XX323	5/16-18	7/16-14	220-072872	.397	.447
220-0XX523	5/16-24				
220-0XX324	3/8-16	1/2-13	220-072874	.453	.510
220-0XX524	3/8-25				
220-0XX325	7/16-14	9/16-12	220-072876	.516	.572
220-0XX525	7/16-20				
220-0XX326	1/2-18	5/8-11	220-072878	.578	.635
220-0XX526	1/2-20				

Dash #	Dim "L"	Dash #	Dim "L"
-5	.312	-27	1.668
-6	.375	-28	1.750
-7	.438	-29	1.812
-8	.500	-30	1.875
-9	.562	-31	1.937
-10	.625	-32	2.000
-11	.688	-34	2.125
-12	.750	-36	2.250
-13	.812	-38	2.375
-14	.875	-40	2.500
-15	.938	-42	2.625
-16	1.00	-44	2.750
-17	1.062	-46	2.875
-18	1.125	-48	3.000
-19	1.188	-50	3.125
-20	1.250	-52	3.250
-21	1.312	-54	3.375
-22	1.375	-56	3.500
-23	1.438	-58	3.625
-24	1.500	-60	3.750
-25	1.562	-62	3.875
-26	1.625	-64	4.000

Maximum overall length of stud is determined by various diameter dimensions, See AcmeIndustrial.com for further details.



Swage-Sert® Thinwall Threaded Inserts



- **Thinwall Permits Close Spacing**
- **Solid One-Piece Design Provides Superior Pull-Out Strength and Torque-Out Capabilities**
- **Lightweight, High Strength**

Acme Swage-Sert® inserts are used to repair stripped, damaged or worn out threads. Additionally, they are employed in original equipment to strengthen threads and extend thread life in soft base materials like aluminum or magnesium.

Swage-Sert inserts have a special thinwall design that allows them to be placed closer together than Acme's traditional threaded inserts. They are locked securely into parent material by swaging the locking knurl into the wall of the parent material.

- **Produced to MIL-I-45932/1.**
Produced to MIL-I-45932/3 if requested.
- **Full range of inch and metric sizes**
- **Available in A286 and 17-4 PH corrosion resistant steels and 4130 alloy steel**
- **Finishes available include cadmium, dry film lube and silver plate**
- **Customized product available: our engineering staff can work with you to make a special Swage-Sert® insert to your drawing or print.**



Typical Applications

Include:

- Electronics**
- Military Hardware**
- Medical Equipment**
- Aerospace Systems**
- Engines**

For complete part number conversions, please visit our website at www.acmeindustrial.com.

Swage-Sert® Thinwall Threaded Inserts MS45932

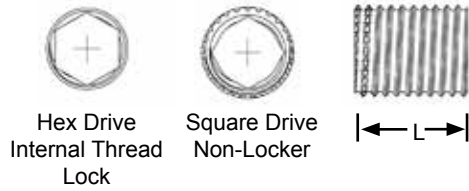

Hex Drive Internal Thread Lock
Square Drive Non-Locker

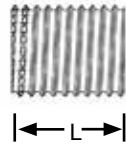

Thread Combination

Material

- 011 - 17-4 PH STL
- 022 - 4130 STL Finish: Cad Plate & DFL
- 031 - A286 SS Finish: DFL
- 033 - A286 Finish: Passivated

225-0XX XXX X

Internal Lock
L - Locking Feature
Blank - no locking

Example

225-011086L

17-4 PH STL
4-40 O.D.

Locker

SWAGE-SERT				INSTALLATION			
Swage-Sert PART NUMBER (L-Internal Thd Lock)	INTERNAL THREAD CLASS 3B	EXTERNAL THREAD CLASS 2A	L LENGTH	INSTALL TOOL PART NUMBER	TAP DRILL SIZE	C'BORE DIA.	C'BORE DEPTH
225-0XX086	2-56	4-40	0.13	225-072702	.113 #33	0.138	0.045
225-0XX086L			0.17	225-072704			0.05
225-0XX110	4-40	8-32	0.19	225-072706	.140 #28	0.164	0.052
225-0XX110L				225-072708			
225-0XX142	6-32	10-32	0.21	225-072710	.166 #19	0.187	0.065
225-0XX142L				225-072712			
225-0XX162	8-32	12-28	0.25	225-072714	.191 #11	0.216	
225-0XX162L				225-072716			
225-0XX194	10-24	1/4-28	0.29	225-072718	.221 #2	0.25	
225-0XX194L	10-32			225-072720			
225-0XX192				225-072718			
225-0XX192L	225-072720						
225-0XX250	1/4-20	5/16-24	0.38	225-072722	.281 9/32	0.312	0.082
225-0XX250L				225-072724			
225-0XX258	1/4-28			225-072722			
225-0XX258L				225-072724			
225-0XX318	5/16-18	3/8-24	0.47	225-072726	.343 11/32	0.375	
225-0XX318L				225-072728			
225-0XX314	5/16-24			225-072726			
225-0XX314L				225-072728			
225-0XX376	3/8-16	7/16-20	0.56	225-072730	.464 Y	0.437	
225-0XX376L	3/8-24			225-072732			
225-0XX374				225-072730			
225-0XX374L	225-072732						
225-0XX434	7/16-14	1/2-20	0.66	225-072734	.468 15/32	0.5	0.113
225-0XX434L	7/16-20			225-072736			
225-0XX430				225-072734			
225-0XX430L	225-072736						
225-0XX503	1/2-13	9/16-24	0.75	225-072738	.531 17/32	0.562	
225-0XX503L	1/2-20			225-072740			
225-0XX500				225-072738			
225-0XX500L	225-072740						
225-0XX562	9/16-12	11/16-12	0.84	225-072742	.625 5/8	0.687	0.15
225-0XX562L	9/16-18			225-072744			
225-0XX568				225-072742			
225-0XX568L	225-072744						
225-0XX621	5/8-11	3/4-16	0.94	225-072746	.703 45/64	0.75	0.156
225-0XX621L	5/8-18			225-072748			
225-0XX628				225-072746			
225-0XX628L	225-072748						
225-0XX750	3/4-10	7/8-20	1.12	225-072750	.844 27/32	0.875	
225-0XX750L				225-072752			
225-0XX756	3/4-16			225-072750			
225-0XX756L				225-072752			



Installation Tools

Acme Industrial offers a complete line of installation/removal tools.

Deluxe Style Insert Tool



Found on pages 7 to 21, 24 to 26

Industrial Style Insert Tool



Found on pages 27, 29 to 31

Integral Key Insert Install Tool



Used for standard applications to install Integral Key Inserts

Found on Page 22 to 23

Integral Key Insert Install Tool



Used for limited space applications to install Integral Key Inserts

Found on Page 22 to 23

Swage-sert Insert Tool



Found on Page 40

Keylocking Stud Install Tool



Found on Page 38

Broaching Tool



Used for very hard parent materials to help broach out slots, so keys of inserts can be driven down.

See AcmeIndustrial.com for more detailed information on all of our Installation Tools.

Also From Acme Industrial Company: Precision Bushings

Huge selection of Acme and ANSI
Standard Bushings, all with “no
counterbore” design which improves
precision and increases bushing life.
Also many special purpose bushings,
liners, gundrill bushings, tool holder
bushings and more.

Shop Online for
Acme Bushings at
store.acmeindustrial.com

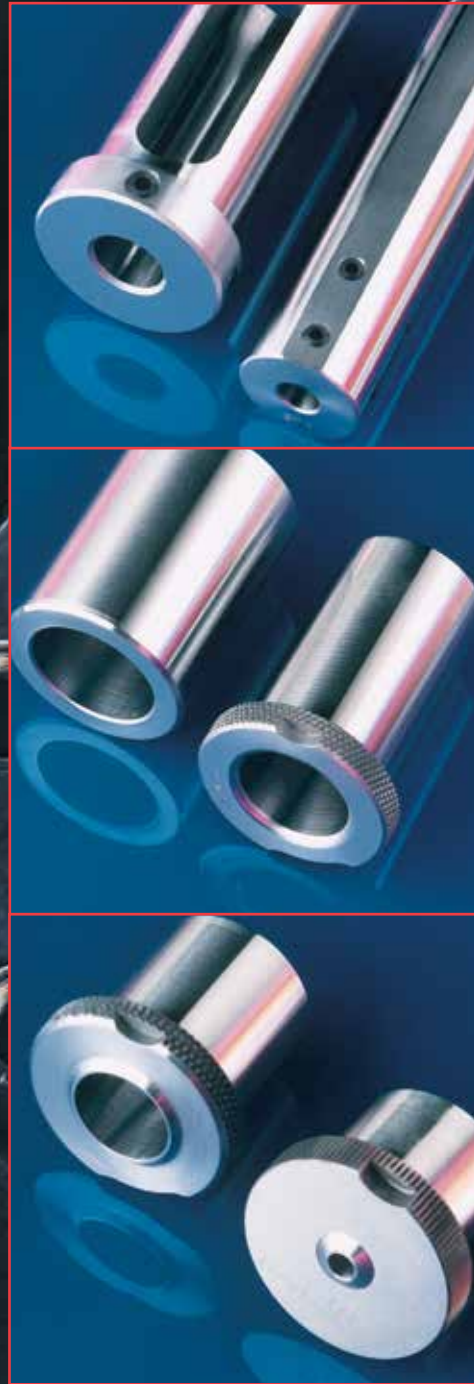

Acme Industrial Company

Subsidiary of Jergens, Inc.



©2019 Acme Industrial Company; all rights reserved 619 1.5M
Form 08032.5M

441 Maple Avenue

Carpentersville, IL 60110

Tel: (847) 428-3911 • (800) 323-5582 • Fax: (847) 428-1820

E-Mail: acmemail@acmeindustrial.com

Web: www.acmeindustrial.com